

SMARTARREDA

# The future is furniture

Design-made educational and work furniture

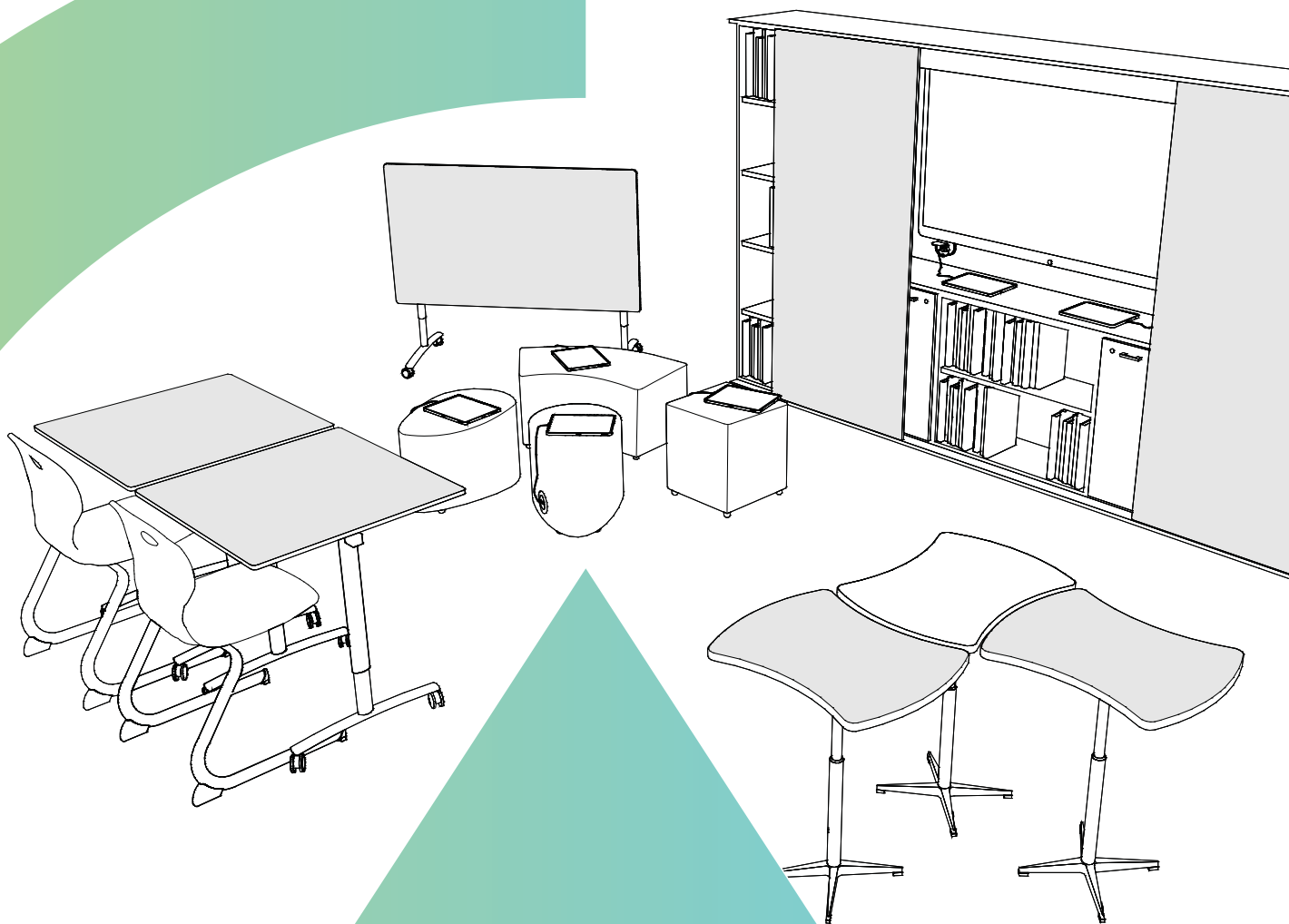



Where innovation meets design

[smartarreda.com](http://smartarreda.com)

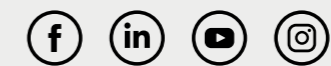

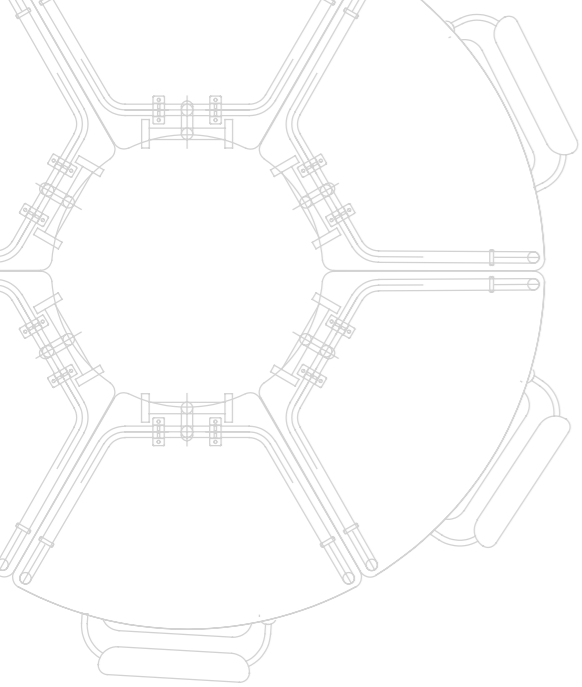

**SMARTARREDA**

## We design spaces that inspire the future

We create educational spaces conceived and designed to promote and facilitate the sharing of knowledge, research, reflection and collaboration. Our furnishing solutions, mobile and modular, are conceived and created to alternate traditional frontal teaching with the «flipped lesson», group work and paired research where students become active subjects of their own education and the teacher takes on the role of moderator and facilitator of learning.

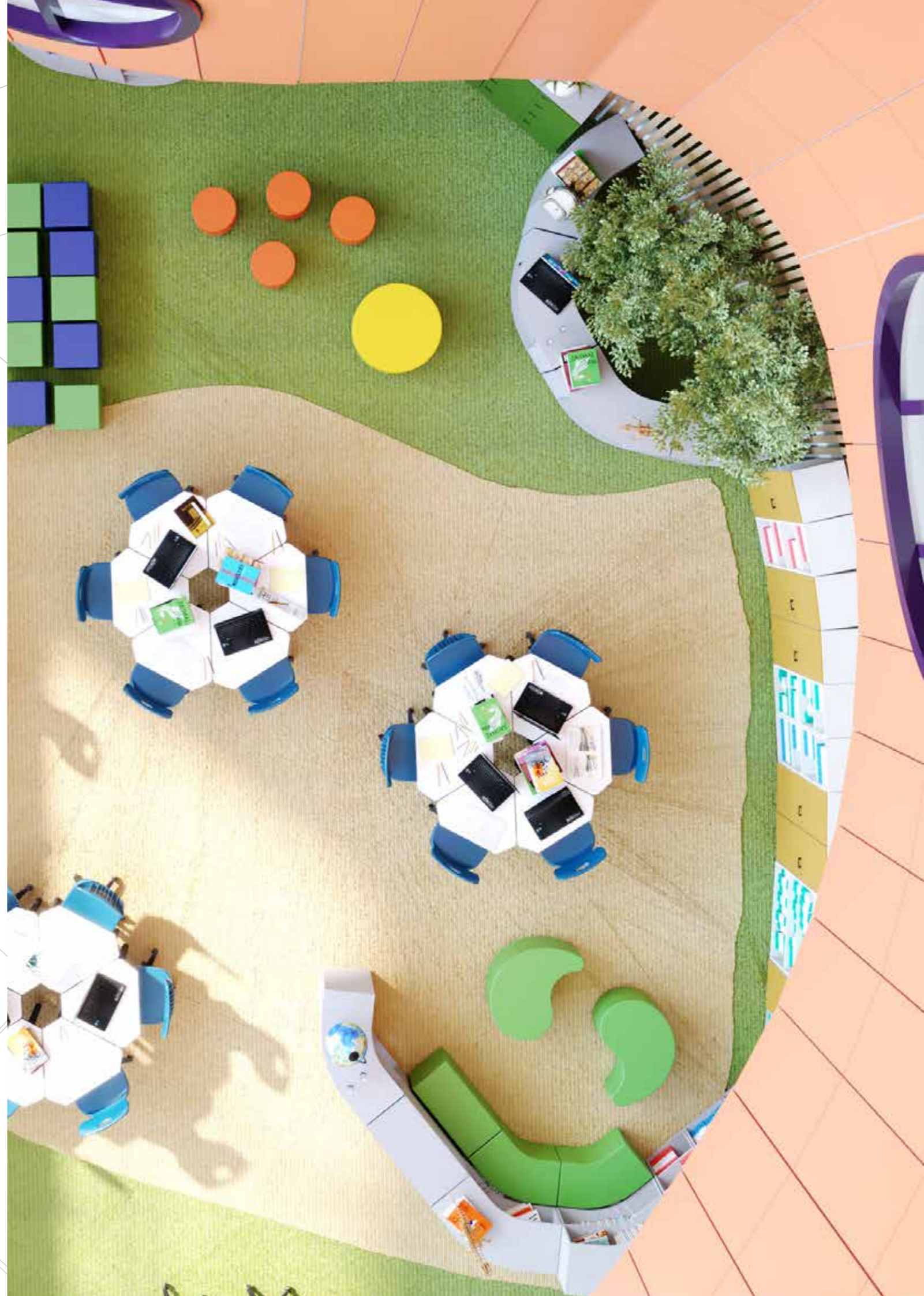
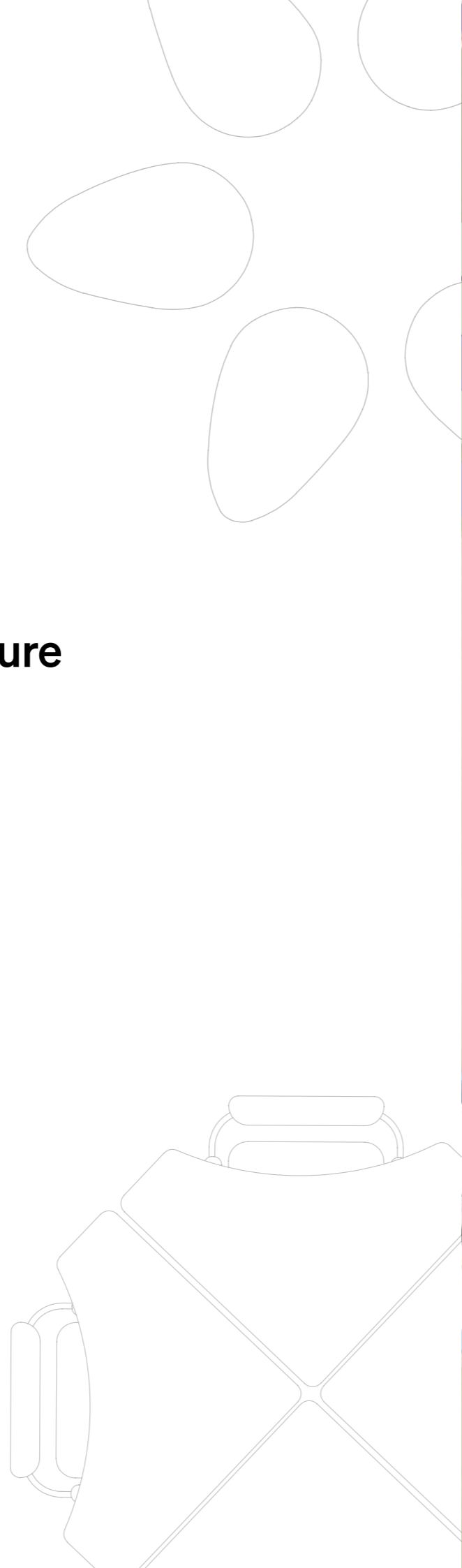

# Welcome to Smartarreda

Born from the experience of Wacebo Europe Srl in the educational market, we are active in the B2B schoolplace sector with services of Consultancy & Design (organizational consultancy, space planning, school place change management) up to the creation and implementation of Innovative Learning Environments. Technology evolves, in parallel, even educational methodologies are adapting to the change. **The new teaching methodologies therefore require dynamic environments, spaces capable of modifying their setting based on the different educational moments.**



## Index

### COLLABORATIVE FURNISHINGS

Technological furnishings	10
Chairs and stools	22
Study and sharing tables	36
Cupboards and bookcases	68
Library Bookshelf System	88
Lockers	98
Poufs and lounge seats	112
Debate	124
Sound-absorbing panels	134
Complements and accessories	150
General sales terms and conditions	161





SMARTARREDA

# Technological furniture

Furnishings with the best digital resources capable of promoting active learning to create the new classrooms of the future! Contact us to talk about how our furnishings can help to enhance your collaborative learning spaces.



## Where innovation meets design



# Smart spaces:

Furniture that powers your life

Standard dimensional and safety certifications for educational institutions:

- CAM (minimum environmental criteria)  
Decree 23 June 2022  
Ministry of Ecological Transition
- UNI EN 14073-2
- UNI EN 14073-3
- UNI EN 14074
- UNI 8601
- UNI 8606
- E1 CLASS
- FSC





## Media Library

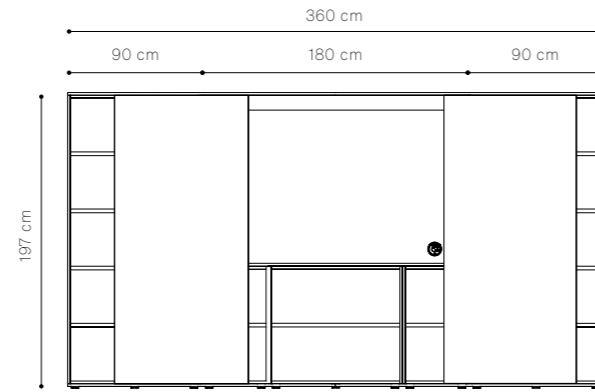

Cod. MEDIACAB **£3,392.00 + VAT ( monitor and small doors not included )**

Cod. PERSONALIZZAZIONE **£357.00 + VAT customization of one single sliding door**

Multimedia bookcase with device charging modules, **size 360 x 50 x h 197 cm**, customizable sliding doors, white color.

Structure color  W

## Media Cart

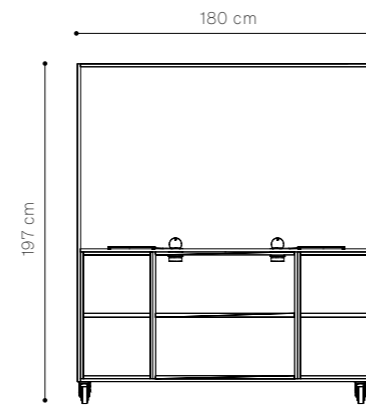

Cod. MEDIACART **£2,640.00 + VAT ( monitor and small doors not included )**

Cod. PERSONALIZZAZIONE **£357.00 + VAT customization of one single sliding door**

Multimedia trolley with device charging modules and writable back, **size 180 x 50 x h 197 cm**, white color.

Structure color  W





Cod. 133914

Single low door with right colored lock **compatible with trolley and multimedia bookcase.**

Colors ● 04B ● 05Y ● 06R ● 07G ● 03W **£84.00 + VAT**  
 ● 03W **£51.00 + VAT**



Cod. 133915

Single low door with left colored lock **compatible with trolley and multimedia bookcase.**

Colors ● 04B ● 05Y ● 06R ● 07G ● 03W **£84.00 + VAT**  
 ● 03W **£51.00 + VAT**



Cod. 133917

Pair of low doors with coloured lock **compatible with trolley and multimedia bookcase.**

Colors ● 04B ● 05Y ● 06R ● 07G ● 03W **£146.0 + VAT**  
 ● 03W **£81.00 + VAT**



Cod. SMARTPLUGP

Hole application on pouf and built-in socket diam mm.80: 1 Schuko socket + 1 USB Charging max 2.4 A.

Colors ● BL ● W **£105.00 + VAT**



Cod. VERTEBRA

2-ways vertebra for cable climbing

● BL ● SL **£70.00 + VAT**



Cod. SMARTCLIMB

Cable duct in fireproof mesh fabric

● BL ● SL **£34.00 + VAT**



Cod. SMARTPLUG1

Application of hole on the table top and recessed socket diam mm.80:  
 1 wireless charging door  
 1 Schuko socket  
 1 RJ45 CAT.6 - 1 USB A+ 1 USB Charging max 2.4 A

● BL **£143.00 + VAT**



Cod. SMARTPLUG2

Application of hole on the table top and recessed socket diam mm.80:  
 1 schuko socket +  
 1 USB Charging max 2.4 A

● BL ● W **£108.00 + VAT**





on

7%

11

12

13

14

15

16

17

18

19

20

21

22

23

24

25

26

27

28

29

30

31

32

33

34

35

36

37

38

39

40

41

42

43

44

45

46

47

48

49

50

51

52

53

54

55

56

57

58

59

60

61

62

63

64

65

66

67

68

69

70

71

72

73

74

75

76

77

78

79

80

81

82

83

84

85

86

87

88

89

90

91

92

93

94

95

96

97

98

99

100

101

102

103

104

105

106

107

108

109

110

111

112

113

114

115

116

117

118

119

120

121

122

123

124

125

126

127

128

129

130

131

132

133

134

135

136

137

138

139

140

141

142

143

144

145

146

147

148

149

150

151

152

153

154

155

156

157

158

159

160

161

162

163

164

165

166

167

168

169

170

171

172

173

174

175

176

177

178

179

180

181

182

183

184

185

186

187

188

189

190

191

192

193

194

195

196

197

198

199

200

201

202

203

204

205

206

207

208

209

210

211

212

213

214

215

216

217

218

219

220

221

222

223

224

225

226

227

228

229

230

231

232

233

234

235

236

237

238

239

240

241

242

243

244

245

246

247

248

249

250

251

252

253

254

255

256

257

258

259

260

261

262

263

264

265

266

267

268

269

270

271

272

273

274

275

276

277

278

279

280

281

282

283

284

285

286

287

288

289

290

291

292

293

294

295

296

297

298

299

300

301

302

303

304

305

306

307

308

309

310

311

312

313

314

315

316

317

318

319

320

321

322

323

324

325

326

327

328

329

330

331

332

333

334

335

336

337

338

339

340

341

342

343

344

345

346

347

348

349

350

351

352

353

354

355

356

357

358

359

360

361

362

363

364

365

366

367

368

369

370

371

372

373

374

375

376

377

378

379

380

381

382

383

384

385

386

387

388

389

390

391

392

393

394

395

396

397

398

399

400

401

402

403

404

405

406

407

408

409

410

411

412

413

414

415

416

417

418

419

420

421

422

423

424

425

426

427

428

429

430

431

432

433

434

435

436

437

438

439

440

441

442

443

444

445

446

447

448

449

450

451

452

453

454

455

456

457

458

459

460

461

462

463

464

465

466

467

468

469

470

471

472

473

474

475

476

477

478

479

480

481

482

483

484

485

486

487

488

489

490

491

492

493

494

495

496

497

498

499

500

501

502

503

504

505

506

507

508

509

510

511

512

513

514

515

516

517

518

519

520

521

522

523

524

525

526

527

528

529

530

531

532

533

534

535

536

537

538

539

540

541

542

543

544

545

546

547

548

549

550

551

552

553

554

555

556

557

558

559

560

561

562

563

564

565

566

567

568

569

570

571

572

573

574

575

576

577

578

579

580

581

582

583

584

585

586

587

588

589

590

591

592

593

594

595

596

597

598

599

600

601

602

603

604

605

606

607

608

609

610

611

612

613

614

615

616

617

618

619

620

621

622

623

624

625

626

627

628

629

630

631

632

633

634

635

636

637

638

639

640

641

642

643

644

645

646

647

648

649

650

651

652

653

654

655

656

657

658

659

660

661

662

663

664

665

666

667

668

669

670

671

672

673

674

675

676

677

678

679

680

681

682

683

684

685

686

687

688

689

690

691

692

693

694

695

696

697

698

699

700

701

702

703

704

705

706

707

708

709

710

711

712

713

714

715

716

717

718

719

720

721

722

723

724

725

726

727

728

729

730

731

732

733

734

735

736

737

738

739

740

741

742

743

744

745

746

747

748

749

750

751

752

753

754

755

756

757

758

759

760

761

762

763

764

765

766

767

768

769

770

771

772

773

774

775

776

777

778

779

780

781

782

783

784

785

786

787

788

789

790

791

792

793

794

795

796

797

798

799

800

801

802

803

804

805

806

807

808

809

810

811

812

813

814

815

816

817

818

819

820

821

822

823

824

825

826

827

828

829

830

831

832

833

834

835

836

837

838

839

840

841

842

843

844

845

846

847

848

849

850

851

852

853

854

855

856

857

858

859

860

861

862

863

864

865

866

867

868

869

870

871

872

873

874

875

876

877

878

879

880

881

882

883

884

885

886

887

888

889

890

891

892

893

894

895

896

897

898

899

900

901

902

903

904

905

906

907

908

909

910

911

912

913

914

915

916

917

918

919

920

921

922

923

924

925

926

927

928

929

930

931

932

933

934

935

936

937

938

939

940

941

942

943

944

945

946

947

948

949

950

951

952

953

954

955

956

957

958

959

960

961

962

963

964

965

966

967

968

969

970

971

972

973

974

975

976

977

978

979

980

981

982

983

984

985

986

987

988

989

990

991

992

993

994

995

996

997

998

999

1000

on

7%

11

12

13

14

15

16

17

18

19

20

21

22

23

24

25

26

27

28

29

30

31

32

33

34

35

36

37

38

39

40

41

42

43

44

45

46

47

48

49

50

51

52

53

54

55

56

57

58

59

60

61

62

63

64

65

66

67

68

69

70

71

72

73

74

75

76

77

78

79

80

81

82

83

84

85

86

87

88

89

90

91

92

93

94

95

96

97

98

99

100

innovation

idea

work

week

innovation

idea

work

week

innovation

idea

work

week



SMARTARREDA

## Chair and stools

The essential design, the ergonomic shape and the great modularity make our collections of polypropylene seats light and easy to handle. All the models in the collection are available with fixed feet, sled or wheels for easy organization.

## Vega collection



# Design goes comfy

Elegant and colorful chairs designed for modern schools

*Standard dimensional and safety certifications for educational institutions:*

· CAM (minimum environmental criteria)

*Decree 23 June 2022*

*Ministry of Ecological Transition*

· UNI EN 1729-1:16

· UNI EN 1729-2:16





## Classic vega



This seat is designed to liven spaces and ensure practicality and comfort: Classic Vega, thanks to its ergonomic design, moves perfectly in every context, both study and work, furnishing every environment with style.

<b>Product code</b>	VEGACL38	<b>£62.00 + VAT</b>
	VEGACL43	<b>£65.00 + VAT</b>
	VEGACL46	<b>£65.00 + VAT</b>

<b>Dimensions</b>	41x41x h 38/43/46 cm
<b>Base</b>	Steel tubular Ø 25 RAL 9006
<b>Seat and backrest</b>	Polypropylene monocoque

**Seat colors** ● B ● G ● R ● Y      **Structure** ●

## Cantilever vega



Combining the comfort of a polypropylene seat with excellent solidity: Cantilever Vega, thanks to its sled feet, guarantees perfect stability, with a minimal design that adapts perfectly to any environment

<b>Product code</b>	VEGACT38	<b>£80.00 + VAT</b>
	VEGACT43	<b>£82.00 + VAT</b>
	VEGACT46	<b>£82.00 + VAT</b>

<b>Dimensions</b>	41x41x h 38/43/46 cm
<b>Base</b>	Steel tubular Ø 25 RAL 9006
<b>Seat and backrest</b>	Polypropylene monocoque

**Seat colors** ● B ● G ● R ● Y      **Structure** ●

## Lift vega



This seat with adjustable height is designed to liven spaces and ensure practicality and comfort: Lift Vega, thanks to its ergonomic design, adapts perfectly to any context, both study and work, furnishing every environment with style.

<b>Product code</b>	VEGAL4052	<b>£85.00 + VAT</b>
<b>Dimensions</b>	42,5x46x h 43/55 cm	
<b>Base</b>	Steel tubular Ø 25 RAL 9006	
<b>Seat and backrest</b>	Polypropylene monocoque	

**Seat colors** ● B ● G ● R ● Y ● BL      **Structure** ●





## Lift stool vega



The excellent practicality of the adjustable height combined with the comfort of the chromed steel footrest: Lift Stool Vega is the perfect synthesis of design and comfort.

<b>Product code</b>	VEGALS6182	<b>£97.00 + VAT</b>
<b>Dimensions</b>	42,5×46x h 61/87 cm	
<b>Base</b>	Steel tubular Ø 25 RAL 9006	
<b>Seat and backrest</b>	Polypropylene monocoque	

**Seat colors** ● B ● G ● R ● Y ● BL    **Structure** ●

## Rubber wheel for Lift Vega



**Product code** LFWHCH01 \_\_\_\_\_ **£6.00 + VAT**

## Rubber foot for Lift or Stool Vega



**Product code** PIEDEVEGAL \_\_\_\_\_ **£6.00 + VAT**



## En one chair



Chair in polypropylene and fiberglass, 100% recyclable, stackable. It offers fantastic ergonomics, the inclined rear legs prevent tipping over.

<b>Product code</b>	EN-ONE4	<b>£66.00 + VAT</b>
	EN-ONE5	<b>£75.00 + VAT</b>
	EN-ONE6	<b>£80.00 + VAT</b>

**Dim. En One 4** 33,5 × 30 x h 38 cm

**Dim. En One 5-6** 36,5 × 38,7 x h 43/46 cm

**Structure** 100% recyclable polypropylene and fiberglass

**Stackable chairs** Up to 21 chairs

**Structure** ● SK ● GR ● RE ● YE

## En one high chair



High chair in polypropylene and fiberglass, 100% recyclable, stackable. It offers fantastic ergonomics, the robust design of this product can support up to 125 kg. Equipped with anti-slip guides, stack up to 12 high chairs comfortably and safely.

**Product code** EN-ONE-HB685 **£136.00 + VAT**

**Dimension** 43 × 40 x h 68,5 cm

**Structure** 100% recyclable polypropylene and fiberglass

**Stackable chairs** Up to 12 high chairs

**Structure** ● SK ● GR ● RE ● YE

## En one stool



One-piece stool in polypropylene and fiberglass, 100% recyclable, stackable. The design of the en one stool is ergonomic and can support up to 125 kg of weight. In addition, the elegant non-slip guides provide additional resistance.

**Product code** EN-ONE-LB685 **£126.00 + VAT**

**Dimension** 43 × 40 x h 68,5 cm

**Structure** 100% recyclable polypropylene and fiberglass

**Stackable chairs** Up to 16 stools

**Structure** ● SK ● GR ● RE ● YE

## Storage trolley



En-one chair trolley is versatile and easy to maneuver. With a maximum capacity of 30 chairs it is suitable for grades 3,4,5 and 6. It weighs 17kg, equipped with two fixed wheels and two swivel wheels, supports a weight limit of 300 kg.

**Product code** CF4038 **£351.00 + VAT**

**Dimension** 49 × 110 x h 90/116,5 cm

**Chairs portability** Up to 30 chairs

**Structure** ● BL

## Backpack Hook



**Product code** EN-ONE-SBH **£9.00 + VAT**

**Compatible with models** EN-ONE-HB and EN-ONE-LB

**Structure** ● SK ● GR ● RE ● YE







SMARTARREDA

# Study and sharing tables

Thanks to the multiple shapes, they allow you to divide spaces intelligently, to create work or study groups in a practical way. Simple shapes that allow creative and functional combinations, to experience the space in an optimal way. Our tables are equipped with anti-noise feet with height adjustment for levelling.

*Standard dimensional and safety certifications for educational institutions*

- CAM (minimum environmental criteria) Decree 23 June 2022 Ministry of Ecological Transition
- UNI EN 1729-1:16
- UNI EN 1729-2:16
- UNI EN 71-3:19
- FSC

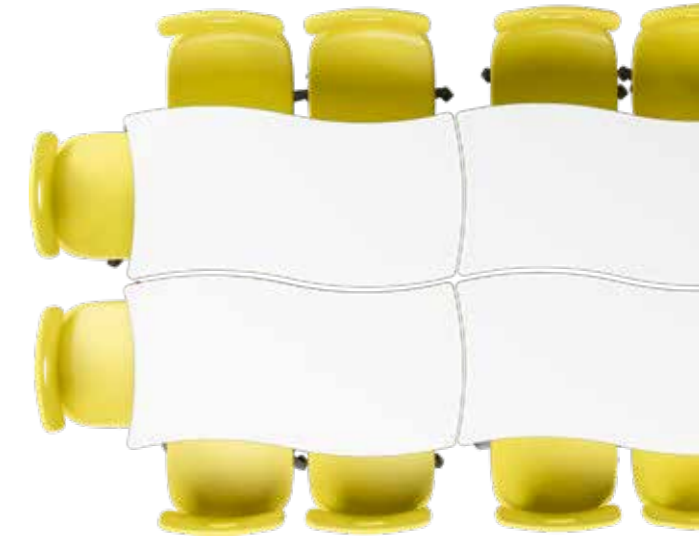
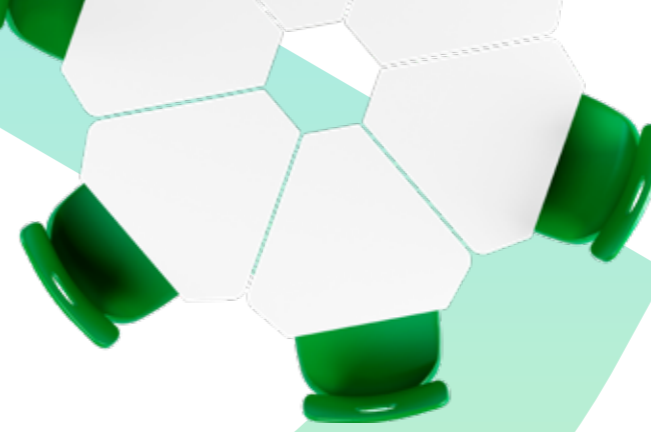

# Tables collection

Stylish, modular tables for dynamic learning



# Design your space

Creative combinations with versatile-shaped study tables





## En core table

Stackable polypropylene table, ideal for both indoor and outdoor use. Versatile, durable and resistant, easily transportable, lightweight and 100% recyclable. It is designed to maximize the usable surface space while maintaining a small footprint.

Size 78,6 × 60 ( EN-CT4, EN-CT5, EN-CT6 ). Available in 5 heights: 53 - 59 - 64 - 71 - 76 cm.



Discover all compatible accessories



Small polypropylene tray  
Cod. TS01 dim. 31,2 × 43 x h 7,5 cm **£13.00 + VAT**

● B ● G ● R ● Y



Undercounter tray guides  
cod. EN-CRUN  
**£29.00 + VAT**

Compatible only with  
En-Core size 5-6



Pen holder  
cod. EN-CTPG  
**£13.00 + VAT**

● NI ● BL ● GR ● RE ● YE



Connection  
cod. EN-CTCON  
**£43.00 + VAT**

● NI ● BL

Product code EN-CT4 **£132.00 + VAT**

Product code EN-CT5 **£135.00 + VAT**

Product code EN-CT6 **£136.00 + VAT**

Colors ● NI ● BL

## Trapezoidal table

Trapezoidal modular table with 18 mm thick plywood worktop. Fixed legs diameter 35 mm and plastic laminate counterframe, PVC edges. Electrostatic epoxy powder coating. Size 120×60 - Available in 3 heights 64 - 70 - 76cm.

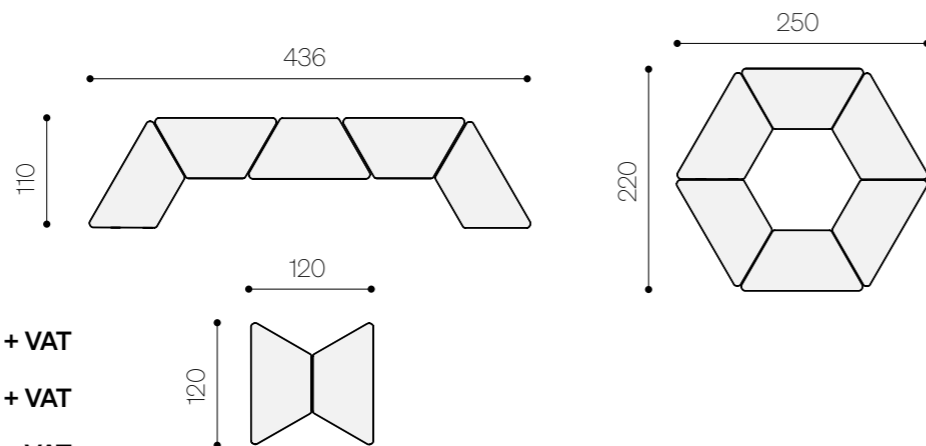

Product code STDESKC-64 **£110.00 + VAT**

Product code STDESKC-70 **£110.00 + VAT**

Product code STDESKC-76 **£110.00 + VAT**

TOP ● W ● B ● G ● R ● Y Structure ● RAL 9006

Edges of the same colour of the top of the table.



## Hexagonal table

Hexagonal shaped table connection for STDESKC with 18 mm MDF TOP and telescopic legs diameter 35 mm. Noise-reducing foot with height adjustment, epoxy-polyester gray ral9006 paint. Adjustable height to choose 64/70/76 cm **Dim. 113.5×99.1x h 64/70/76 cm.**

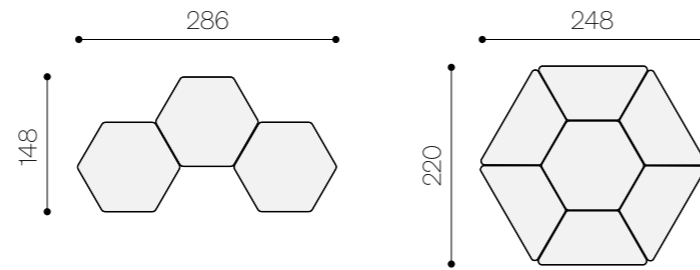

Product code STDESKC-64-76W £148.00 + VAT

Structure ● RAL 9006 Edge ● RAL 9006 Table top ● White

## Mira table

Segment table usable as a single or modular island by joining up to 6 elements. Top in 25 mm white MDF and rounded edge in grey polyurethane. Structure in steel tube Ø 30 mm, sheet thickness 1.5 mm. **Dim. 92.1 × 62.3 x h 70/76 cm.**

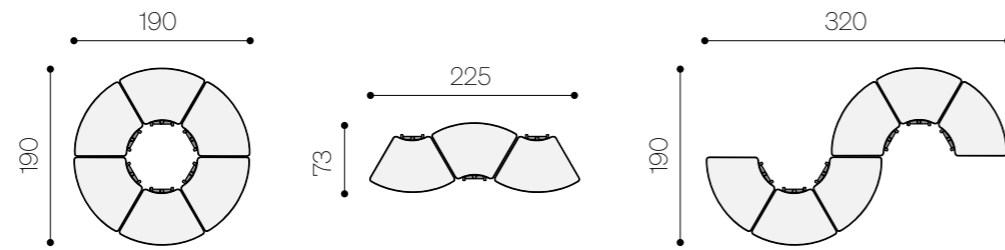

Product code MIRARBC6076 £140.00 + VAT MIRARBC6070 £139.40 + VAT

Table top ● W ● B ● G ● R ● Y Structure ● RAL 9006 Edge ● RAL 9006

## Atria Table

Diamond table usable as a single or modular island by joining up to 6 pieces. Top in 25 mm white MDF and rounded edge in grey polyurethane. Structure in Ø65 mm steel tube, sheet thickness 1.5 mm. **Dim. 78×68xh52/58/64/70/76 cm.**

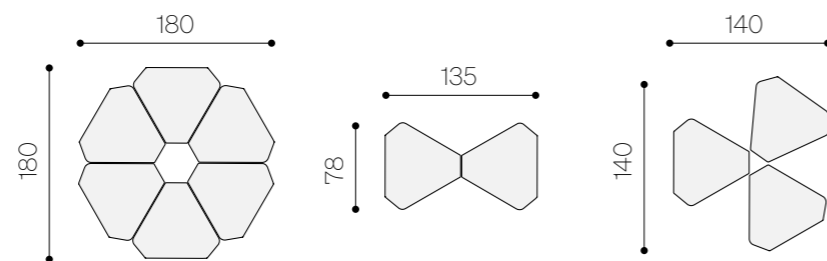

Product code ATR5276PUW £123.00 + VAT

Structure ● RAL 9006 Edge ● RAL 9006 Table top ● White

## Spica table

Ergonomic table that can be used as a single or as a modular island by joining up to 4 elements. 25 mm white MDF top and rounded edge in grey polyurethane. Steel tube structure Ø 65 mm, sheet thickness 1.5 mm. **Dim. 70×70xh52/58/64/70/76 cm.**

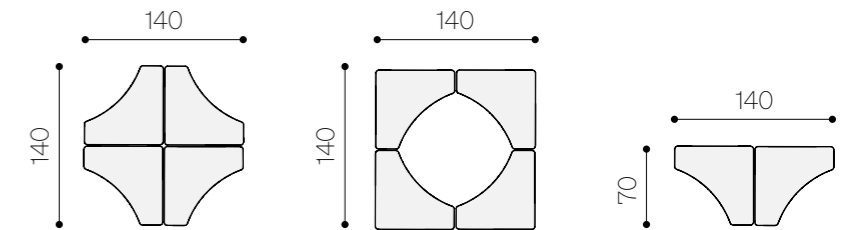

Product code SPC5276PUW-MDFT £123.00 + VAT

Structure ● RAL 9006 Edge ● RAL 9006 Table top ● White

## Lira table

Ergonomic table usable as single or modular island. Top in 25 mm white MDF and rounded edge in grey polyurethane. Structure in steel tube Ø 65 mm, sheet thickness 1.5 mm. **Dim. 121.7×63.8x h 52/58/64/70/76 cm.**

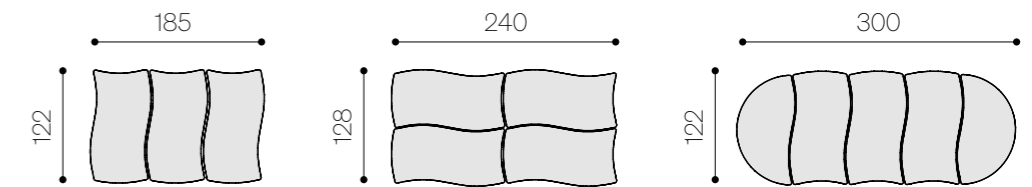

Product code LIRAC5276PUW £172.00 + VAT

Structure ● RAL 9006 Edge ● RAL 9006 Table top ● White

## Sirio table

Ergonomic table usable as single or modular island. Top in 25 mm white MDF and rounded edge in grey polyurethane. Structure in steel tube Ø 65 mm, sheet thickness 1.5 mm. **Dim. 119.4 × 63.2 x h 52/58/64/70/76 cm.**

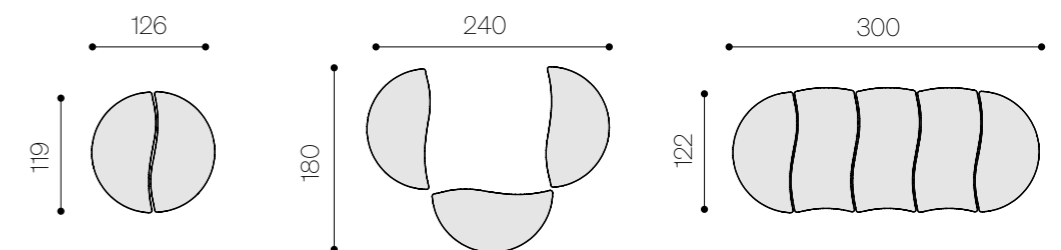

Product code SIRIOC5276PUW £155.00 + VAT

Structure ● RAL 9006 Edge ● RAL 9006 Table top ● White





## Idra table 80×60

Ergonomic table usable as single or modular island. Top in 25 mm white MDF and rounded edge in grey polyurethane. Structure in steel tube Ø 65 mm, sheet thickness 1.5 mm. **Dim. 80×60x h 52/58/64/70/76 cm.**

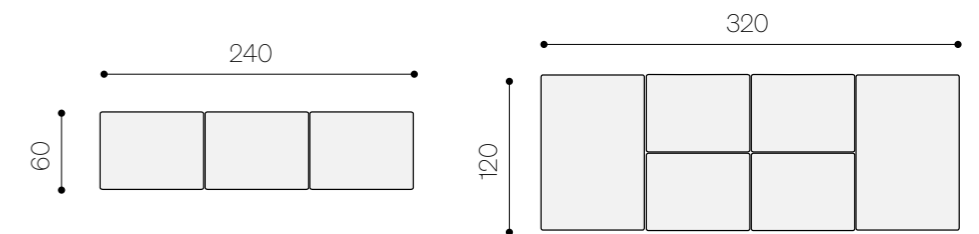

**Product code** IDRA52768X6PUW **£133.00 + VAT**

**Structure** ● RAL 9006 **Edge** ● RAL 9006 **Table top** ● White

## Idra table 80×80

Ergonomic table usable as single or modular island. Top in 25 mm white MDF and rounded edge in grey polyurethane. Structure in steel tube Ø 65 mm, sheet thickness 1.5 mm. **Dim. 80×80x h 52/58/64/70/76 cm.**

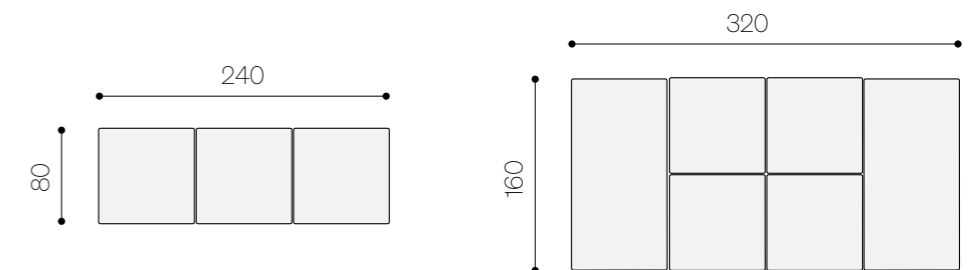

**Product code** IDRA52768X8PUW **£149.00 + VAT**

**Structure** ● RAL 9006 **Edge** ● RAL 9006 **Table top** ● White

## Idra table 120×80

Ergonomic table usable as single or modular island. Top in 25 mm white MDF and rounded edge in grey polyurethane. Structure in steel tube Ø 65 mm, sheet thickness 1.5 mm. **Dim. 120×80x h 52/58/64/70/76 cm.**

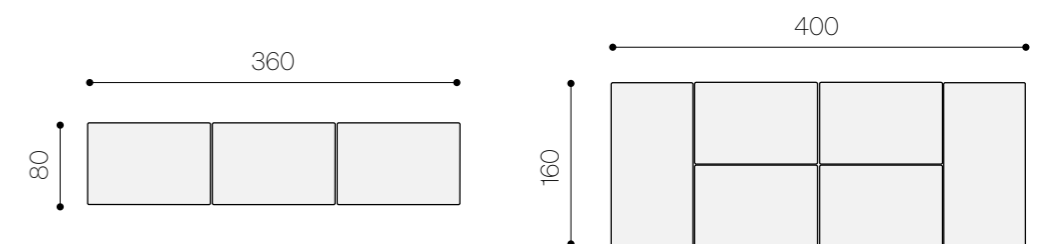

**Product code** IDRA527612X8PU **£183.00 + VAT**

**Structure** ● RAL 9006 **Edge** ● RAL 9006 **Table top** ● W ● B ● G ● R ● Y

Add color code to item code when ordering.

## Idra Table 160×60

Ergonomic table usable as single or modular island. Top in 25 mm white MDF and rounded edge in grey polyurethane. Structure in steel tube Ø 65 mm, sheet thickness 1.5 mm. **Dim. 160×60x h 52/58/64/70/76 cm.**

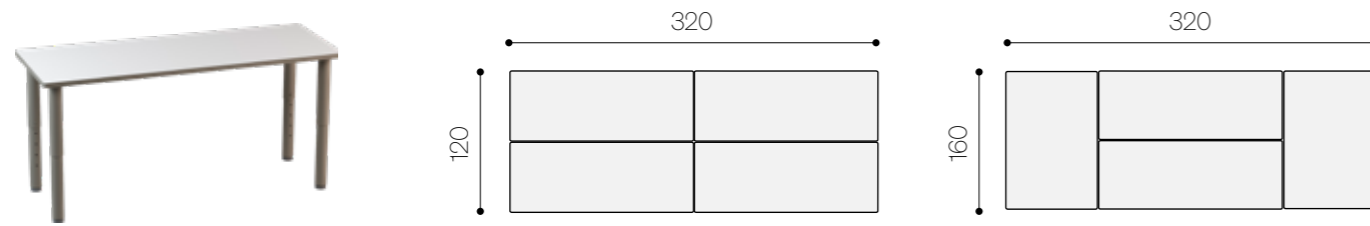

**Product code** IDRA527616X6PUW **£189.00 + VAT**

**Structure** ● RAL 9006 **Edge** ● RAL 9006 **Table top** ● White

## Idra Table 160×80

Ergonomic table usable as single or modular island. Top in 25 mm white MDF and rounded edge in grey polyurethane. Structure in steel tube Ø 65 mm, sheet thickness 1.5 mm. **Dim. 160×80x h 52/58/64/70/76 cm.**

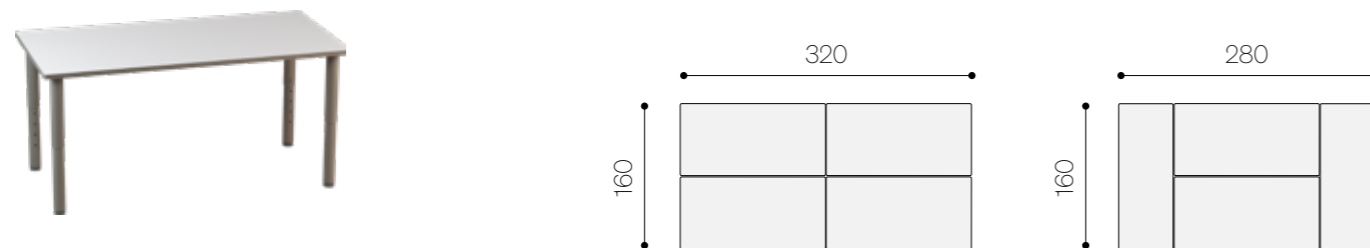

**Product code** IDRA527616X8PUW **£224.00 + VAT**

**Structure** ● RAL 9006 **Edge** ● RAL 9006 **Table top** ● White

## Idra Table 180×60

Ergonomic table usable as single or modular island. Top in 25 mm white MDF and rounded edge in grey polyurethane. Structure in steel tube Ø 65 mm, sheet thickness 1.5 mm. **Dim. 180×60x h 52/58/64/70/76 cm.**

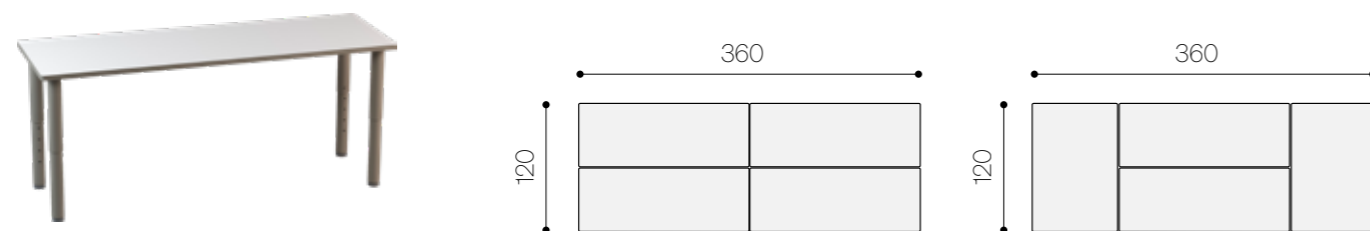

**Product code** IDRA527618X6PUW **£229.00 + VAT**

**Structure** ● RAL 9006 **Edge** ● RAL 9006 **Table top** ● White

## Idra Table 180×80

Ergonomic table usable as single or modular island. Top in 25 mm white MDF and rounded edge in grey polyurethane. Structure in steel tube Ø 65 mm, sheet thickness 1.5 mm. **Dim. 180×80x h 52/58/64/70/76 cm.**

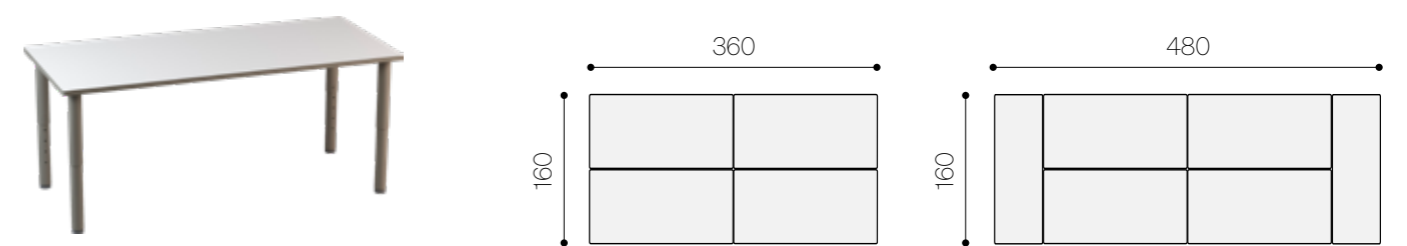

**Product code** IDRA527618X8PUW **£242.00 + VAT**

**Structure** ● RAL 9006 **Edge** ● RAL 9006 **Table top** ● White

## Idra Table 180×60 h100

Ergonomic table usable as single or modular island. Top in 25 mm white MDF and rounded edge in grey polyurethane. Structure in steel tube Ø 65 mm, sheet thickness 1.5 mm. **Dim. 180×60x h 100 cm.**

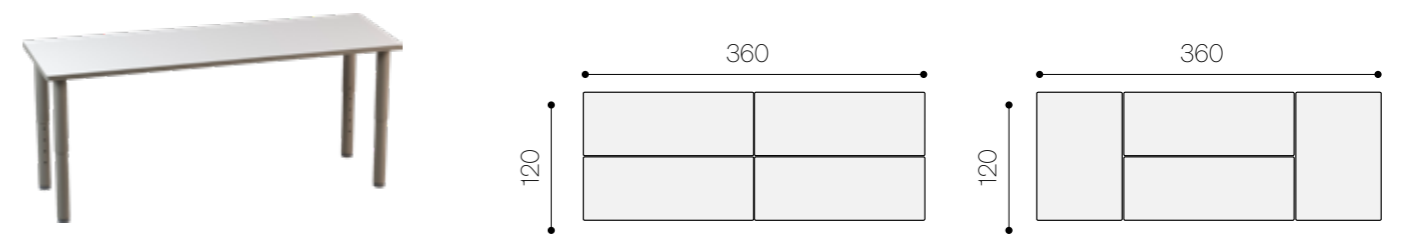

**Product code** IDRA10018X6PUW **£201.00 + VAT**

**Structure** ● RAL 9006 **Edge** ● RAL 9006 **Table top** ● White

## Idra Table 180×80 h100

Ergonomic table usable as single or modular island. Top in 25 mm white MDF and rounded edge in grey polyurethane. Structure in steel tube Ø 65 mm, sheet thickness 1.5 mm. **Dim. 180×80x h 100 cm.**

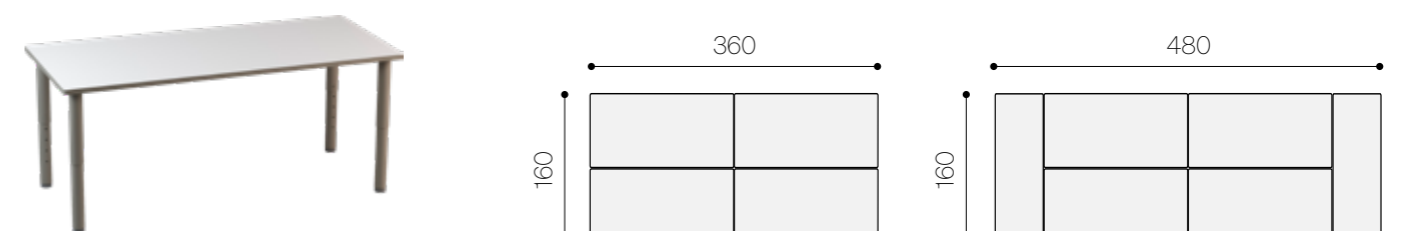

**Product code** IDRA10018X8PUW **£238.00 + VAT**

**Structure** ● RAL 9006 **Edge** ● RAL 9006 **Table top** ● White



## Writable Giotto table 180×80

Tilting desk with 25 mm thick MDF top, Ø66 mm steel tube structure, 41 × 1.5 mm, available with writable white MDF top. Giotto is in fact designed to adapt to all spaces, thanks to its tilting top that makes it easy to stow after use. Its design, perfect for both study and work, is also particularly suitable for home use, ideal in companies and also for smart working.



**Product code** GTT719618X8W **£392.00 + VAT**

**Dimension** 180×80x h 71,3/77,3/83,3/97,3 cm

**Structure**  RAL 9016  RAL 9006 **Edge**  RAL 9006 **Table top**  White

## Giotto table 80×80

Ideal for study or work groups, whatever the space available: the Giotto folding table is available in multiple sizes and represents the perfect solution for setting up and making the most of any environment. 25 mm thick MDF top, Ø66 mm steel tube structure, 41 × 1.5 mm, available with white MDF top. The design makes it perfect for both study and work.



**Product code** GTT71968X8 **£253.00 + VAT**

**Dimension** 80×80x h 71,3/77,3/83,3/97,3 cm

**Structure**  RAL 9016  RAL 9006 **Edge**  RAL 9006 **Table top**  White

## Giotto table 120×80

Ideal for study or work groups, whatever the space available: the Giotto folding table is available in multiple sizes and represents the perfect solution for setting up and making the most of any environment. 25 mm thick MDF top, Ø66 mm steel tube structure, 41 × 1.5 mm, available with white MDF top. The design makes it perfect for both study and work.



**Product code** GTT719612X8 **£261.00 + VAT**

**Dimension** 120×80 x h 71,3/77,3/83,3/97,3 cm

**Structure**  RAL 9016  RAL 9006 **Edge**  RAL 9006 **Table top**  White



## Giotto table 160x80

Ideal for study or work groups, whatever the space available: the Giotto folding table is available in multiple sizes and represents the perfect solution for setting up and making the most of any environment. 25 mm thick MDF top, Ø66 mm steel tube structure, 41 x 1.5 mm, available with white MDF top. The design makes it perfect for both study and work.



**Product code** GTT719616X8 **£306.00 + VAT**  
**Dimension** 160x80x h 71,3/77,3/83,3/97,3 cm

**Structure** ● RAL 9016 ● RAL 9006 **Edge** ● RAL 9006 **Table top** ● White

## Giotto table 180x80

Ideal for study or work groups, whatever the space available: the Giotto folding table is available in multiple sizes and represents the perfect solution for setting up and making the most of any environment. 25 mm thick MDF top, Ø66 mm steel tube structure, 41 x 1.5 mm, available with white MDF top. The design makes it perfect for both study and work.



**Product code** GTT719618X8 **£384.00 + VAT**  
**Dimension** 180x80 x h 71,3/77,3/83,3/97,3 cm

**Structure** ● RAL 9016 ● RAL 9006 **Edge** ● RAL 9006 **Table top** ● White

## Bellatrix table

Ergonomic table for 3 people as a single, expandable combined with other elements. Top in 25 mm white mdf and rounded edge in gray polyurethane. Structure in steel tube Ø 65 mm, sheet thickness 1.5 mm. Dim. 120x112x h 52/58/64/70/76 cm

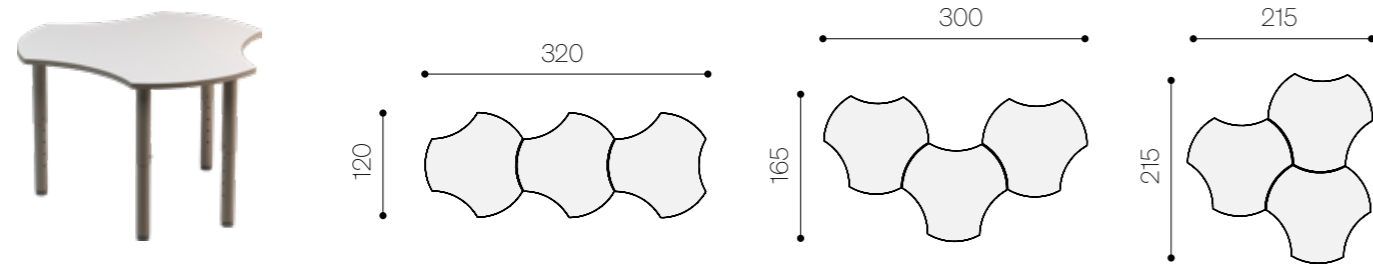

**Product code** BLTX5276PU **£213.00 + VAT**

**Structure** ● RAL 9006 **Edge** ● RAL 9006 **Table top** ● W ● B ● G ● R ● Y

## Moon table

Ergonomic table usable as single or modular island. Top in 25 mm white MDF and rounded edge in grey polyurethane. Structure in steel tube Ø 65 mm, sheet thickness 1.5 mm. **Dim. 120 x 101 x h 52/58/64/70/76 cm.**

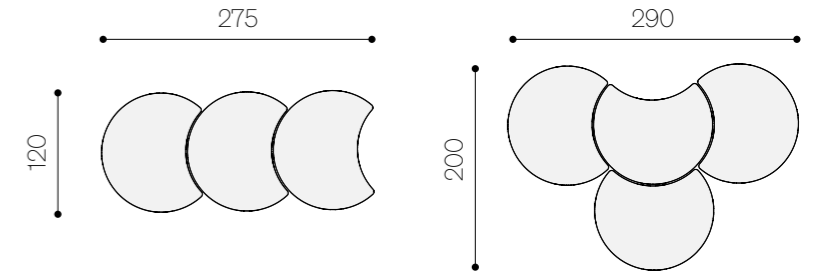

**Product code** MOON5276PU **£183.00 + VAT**

**Structure** ● RAL 9006 **Edge** ● RAL 9006 **Table top** ● W ● B ● G ● R ● Y

## Aries table

Ergonomic table usable as single or modular island. Top in 25 mm white MDF and rounded edge in grey polyurethane. Structure in steel tube Ø 65 mm, sheet thickness 1.5 mm. **Dim. 150 x 75 x h 52/58/64/70/76 cm.**

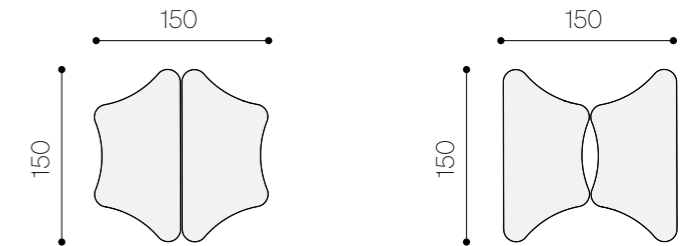

**Product code** ARIES5276PU **£218.00 + VAT**

**Structure** ● RAL 9006 **Edge** ● RAL 9006 **Table top** ● W ● B ● G ● R ● Y

## Lynx table

Ergonomic table usable as single or modular island. Top in 25 mm white MDF and rounded edge in grey polyurethane. Structure in steel tube Ø 65 mm, sheet thickness 1.5 mm. **Dim. 120 x 53 x h 52/58/64/70/76 cm.**

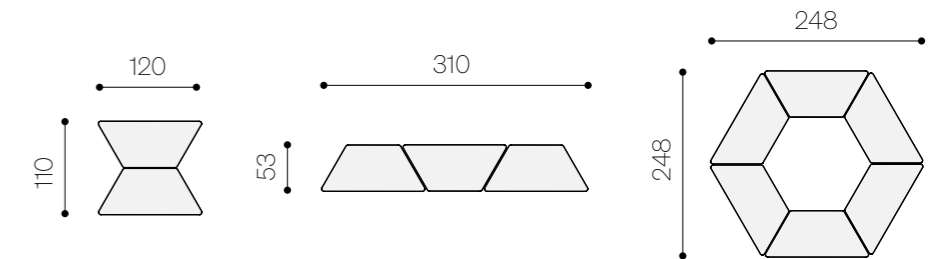

**Product code** LYNX5276PUW **£176.00 + VAT**

**Structure** ● RAL 9006 **Edge** ● RAL 9006 **Table top** ● White



## Vela table

Ergonomic table usable as a single or modular island by joining up to 5 elements. Top in 25 mm white MDF and rounded edge in grey polyurethane. Structure in steel tube  $\varnothing$  65 mm, sheet thickness 1.5 mm. **Dim. 120x160xh52/58/64/70/76 cm.**

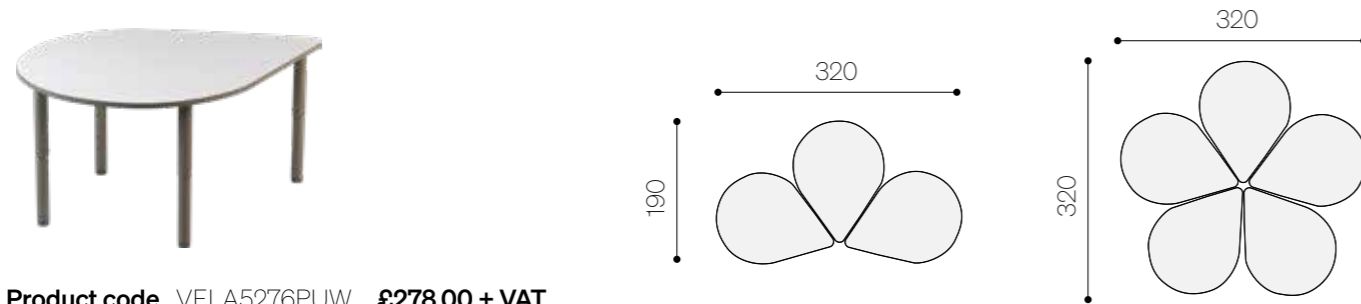

Product code VELA5276PUW £278.00 + VAT

Structure ● RAL 9006 Edge ● RAL 9006 Table top ● White

## Perseo table

Ergonomic table usable as a single with 25 mm white MDF top and rounded edge in grey polyurethane. Steel tube structure  $\varnothing$  65 mm, sheet thickness 1.5 mm. **Dim. 200x120x h 52/58/64/70/76 cm.** Perseo is synonymous with ergonomics and practicality of use: its soft and welcoming shapes can comfortably accommodate up to 6 people, improving productivity in both the workplace and teaching environments.



Product code PRS5276PUW £339.00 + VAT

Structure ● RAL 9006 Edge ● RAL 9006 Table top ● White

## Otto table

Ergonomic table usable as a single, Top in 25 mm white mdf and rounded edge in gray polyurethane. Steel tube structure  $\varnothing$  65 mm, sheet thickness 1.5 mm. **Dim. 180x90xh52/58/64/70/76 cm.** Otto perfectly embodies innovative teaching: four people can comfortably fit between its soft shapes.

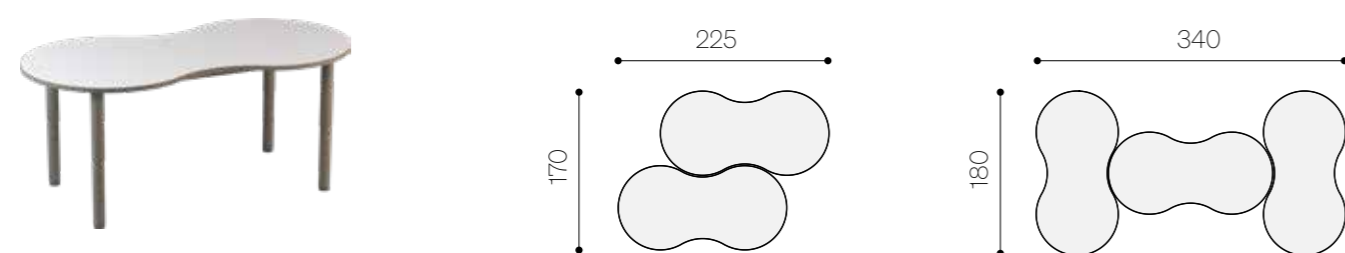

Product code OT5276PUW £323.00 + VAT

Structure ● RAL 9006 Edge ● RAL 9006 Table top ● White

## Apus table

Ergonomic table usable as single or modular island. Top in 25 mm white MDF and rounded edge in grey polyurethane. Structure in steel tube  $\varnothing$  65 mm, sheet thickness 1.5 mm. **Dim. 150 x 102.5 x h 52/58/64/70/76 cm.**

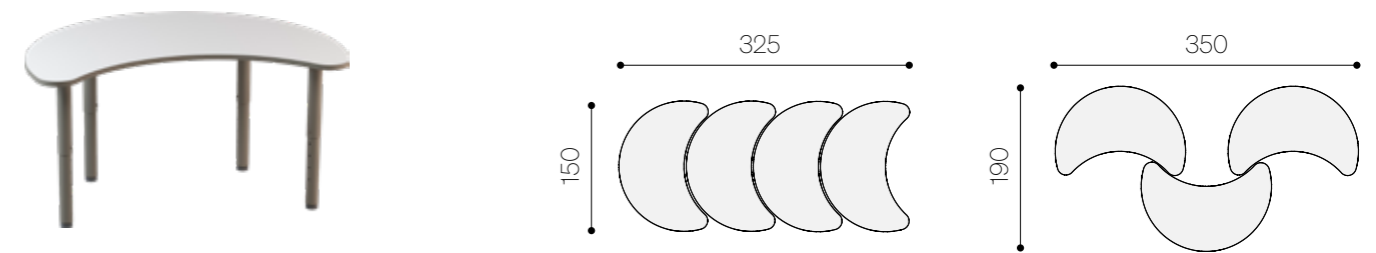

Product code APUS5276PUW £257.00 + VAT

Structure ● RAL 9006 Edge ● RAL 9006 Table top ● White

## Delta table

Ergonomic table usable as single or modular island. Top in 25 mm white MDF and rounded edge in grey polyurethane. Structure in steel tube  $\varnothing$  65 mm, sheet thickness 1.5 mm. **Dim. 180 x 90 x h 52/58/64/70/76 cm.**

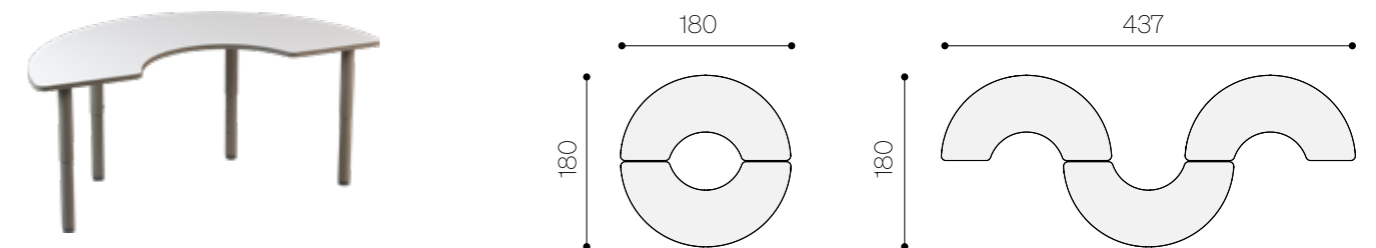

Product code DLT5276PU £338.00 + VAT

Structure ● RAL 9006 Edge ● RAL 9006 Table top ● W ● B ● G ● R ● Y

## Orion table

Table in white mdf 25 mm thick rectangular shape with two concave sides and two convex **dimensions 66 x 51.5 adjustable height with gas piston from 47 to 70 cm.** Chromed metal structure with a single central metal tube and four spokes with anti-noise feet.

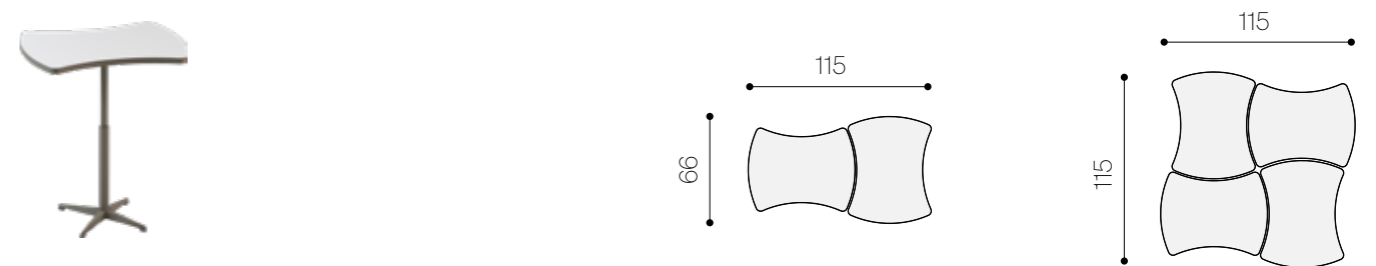

Product code ORN5276PUW £106.00 + VAT

Structure ● RAL 9006 Edge ● RAL 9006 Table top ● White



## Multifunctional table

# Smart design, freedom of movement, maximum productivity

Designed for dynamic school environments, this multifunctional table combines solidity, style and maximum practicality. The metal frame guarantees resistance and durability, while the wooden top available in white, sage green, garnet red and air force blue - adds a touch of color and personality to spaces. Thanks to the wheels with locking system, it is easy to move and reconfigure based on activities, making it ideal for classrooms, laboratories, libraries and flexible environments. The modern and clean design helps create an orderly and stimulating environment, promoting concentration and productivity.



## One table, infinite possibilities, design the space that grows with your ideas

Our multifunctional table was created to adapt to every educational and creative need. Sold in a solid and essential basic configuration, it is designed to evolve over time thanks to a complete range of optional accessories that amplify its functionality and personality.



4 colors available

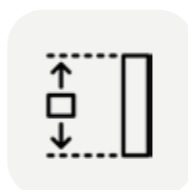

working top at h. 72 or 100 cm

## One top, two heights maximum versatility

The structure is intelligently designed to adapt to different teaching and operational needs: the top can be mounted at 72 cm for traditional use or at 100 cm for standing or dynamic activities, always guaranteeing ergonomics and comfort.



Eye-catching design



Collaborative learning

## The base is just the beginning, add what you need



You can start with the standard table and add only what you need, when you need it. Do you want greater mobility? The wheels with brakes offer agile and safe movements. Do you need to organize materials and tools? You can integrate the tool holder wall with back, the lower back or the upper back, to improve space management. The upper cap adds an aesthetic and functional touch, while the sheet metal sides, right and left, complete the structure, giving solidity and continuity to the design. And for those who want a distinctive and natural element, a designer flowerpot is also available: a detail that brings a touch of greenery and well-being.



Multifunctional table with metal frame and wooden tops, configurable in two heights (72 cm or 100 cm). Ideal for educational environments and laboratories

Code **TLAB180** £1,186.00 + VAT

Dim. 188 x 70 x h 190 cm

Code **TLAB160** £1,134.00 + VAT

Dim. 166 x 70 x h 190 cm

Strutt. ● 4002 ● 7035 ● 2006 ● 3900 ● 2008

Wooden top ● 4002 ● 0041 ● 2006 ● 3900

## Optional accessories



### Flowerpot ( plants not included )

Code **TFIORIERA** £96.00 + VAT

Dim. 78 x 28 x h 16 cm

Colors ● 4002 ● 7035 ● 2006 ● 3900 ● 2008



### Right side sheet metal

Code **TFIANCODX** £75.00 + VAT

Colors ● 4002 ● 7035 ● 2006 ● 3900 ● 2008



### Left side sheet metal

Code **TFIANCOSX** £75.00 + VAT

Colors ● 4002 ● 7035 ● 2006 ● 3900 ● 2008



### Set of wheels ( 4 pcs )

Max load 200 kg, 2 wheels with brake **Diam. 65 mm - h 7 cm**

Code **TRUOTE** £64.00 + VAT

Colors ● W ● BL



### Wooden top hat

Code **TCAP180 L=180cm** £88.00 + VAT

Code **TCAP160 L=160cm** £75.00 + VAT

Colors ● 4002 ● 0041 ● 2006 ● 3900



### Wooden lower shelf

Code **TMENSINF180 L=180cm** £170.00 + VAT

Code **TMENSINF160 L=160cm** £158.00 + VAT

Colors ● 4002 ● 0041 ● 2006 ● 3900

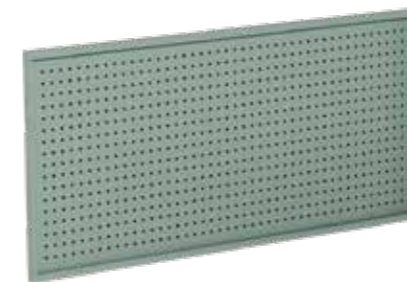

### Tool holder wall + back

Code **TPARETE180 L=180cm** £380.00 + VAT

Code **TPARETE160 L=160cm** £353.00 + VAT

Colors ● 4002 ● 7035 ● 2006 ● 3900 ● 2008



### Lower back

Code **TSCHIENAINF180 L=180cm** £142.00 + VAT

Code **TSCHIENAINF160 L=160cm** £127.00 + VAT

Colors ● 4002 ● 7035 ● 2006 ● 3900 ● 2008



### Upper back

Code **TSCHIENASUP180 L=180cm** £102.00 + VAT

Code **TSCHIENASUP160 L=160cm** £93.00 + VAT

Colors ● 4002 ● 7035 ● 2006 ● 3900 ● 2008



SMARTARREDA

## Cupboards and bookcases

"Tidy" is the key word and an essential element to help you work at your best: our cupboards and bookcases are both flexible and portable, and will provide you with the ample storage space so you can focus on more important tasks.

*Standard dimensional and safety certifications for educational institutions:*

- CAM (minimum environmental criteria)
- UNI EN 14073-2
- UNI EN 14073-3
- UNI EN 14074
- UNI 8601
- UNI 8606
- FSC
- E1 CLASS

## Solidity and minimal style

Where all the material finds its place in an orderly fashion



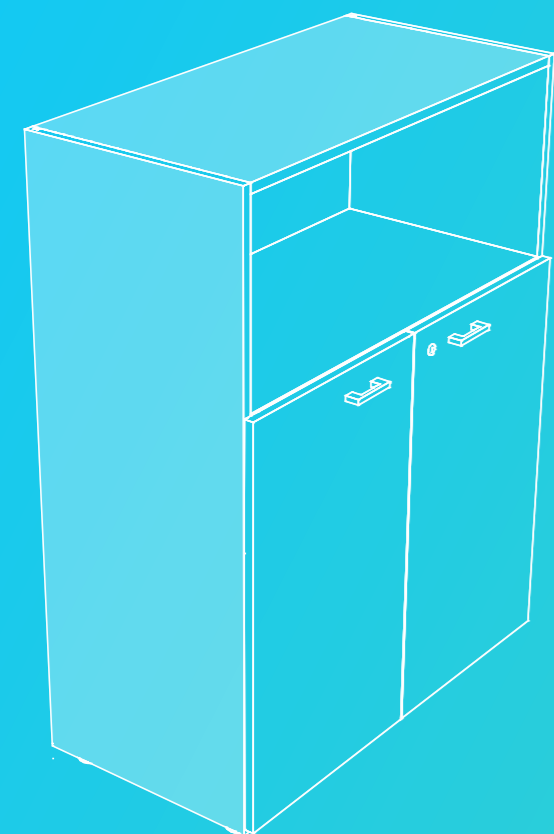

## Solidity and minimal style

where everything finds its place in an orderly manner

### Overview

All components are supplied disassembled and packaged in a triple folding cardboard wrapping, with perimeter protection strips and for fillings. The corners are protected, where necessary, with shock-absorbent corner guards. The packaging is closed with adhesive tape and heat-sealed nylon strapping.

### Wood characteristics

Volume UNI EN 323: 1994	650 KG / m <sup>3</sup> ± 10%
Relative humidity UNI EN 322: 1994	5 - 13 %
Thickness tolerance UNI EN 324-1/1994	± 0.3 mm
24hours swelling UNI EN 317: 1994	15 %
Detachment of external layers UNI EN 311: 2003	0.8 Mpa
Static bending UNI EN 310: 1994	16 Mpa
Elasticity's module UNI EN 310: 1994	1600 Mpa
Screw extractions on the edges UNI EN 320: 1994	> 400 Mpa
Formaldehyde content UNI EN ISO 12460 -3 :2015	≤ a 3,5 mg H <sub>2</sub> CO (m <sup>2</sup> X H)

### Structure panels

18 mm wood particles, melamine faced, 0.4 mm melamine edge, available in white

### Base

4 nylon feet with height adjustment range 15 mm

### Shelves

25 mm wood particles, melamine faced, 0.4 mm melamine edge in the same color as the surface. White color

### Doors

18 mm wood particles in melamine laminate, 0.4 mm melamine edge, available in 5 colors: white, blue, yellow, red and green. Perimeter edges in 2 mm ABS in the same color as the surface

### Hinges

Metal wing with 110° opening, complete with bases, with 3D adjustment

### Lock

A removable cylinder supplied with double folding accident prevention key.

### Handle

"Bridge" shape, 64 mm interaxis made of white polypropylene. Concealed hardware.

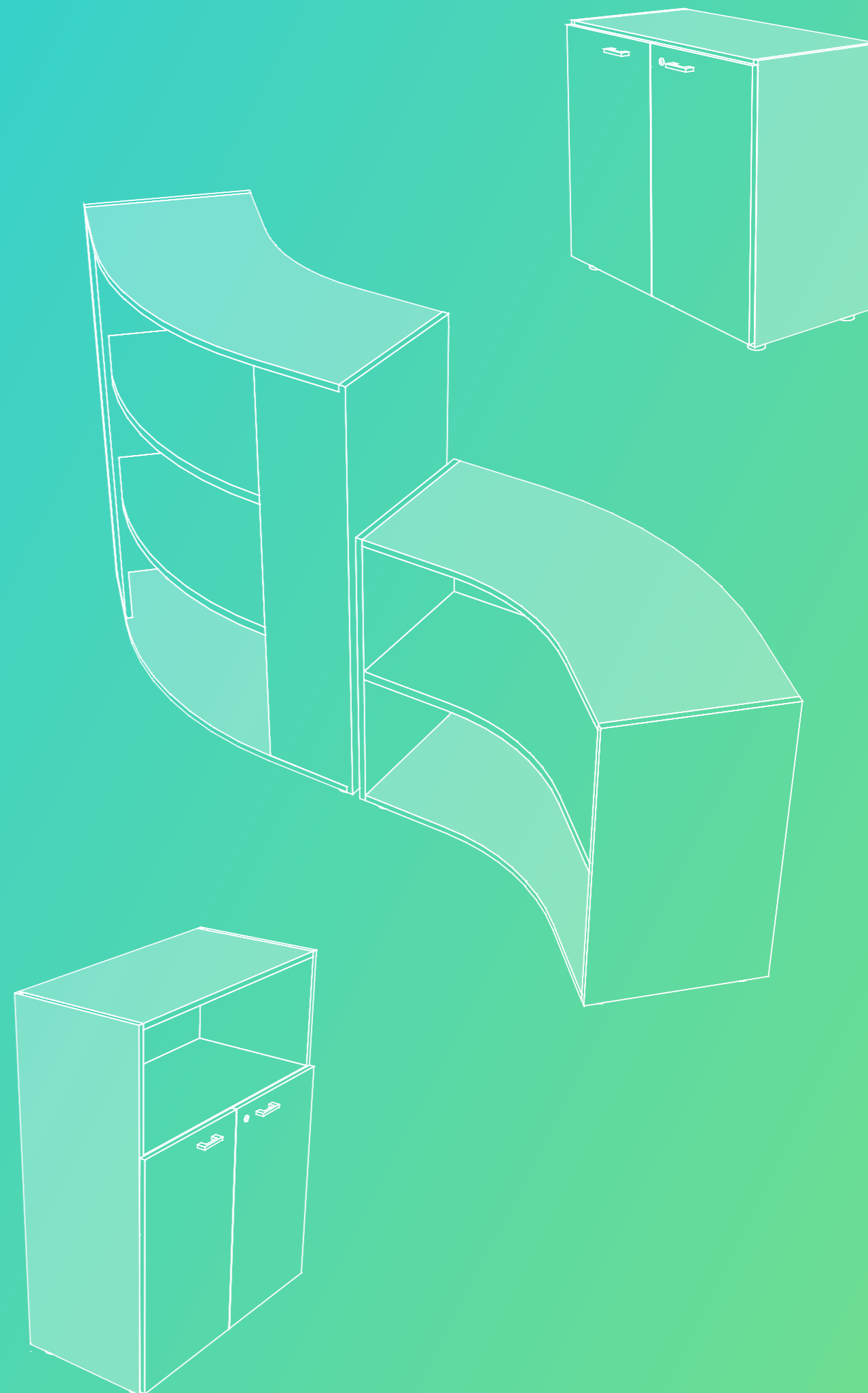



## Low open bookcase

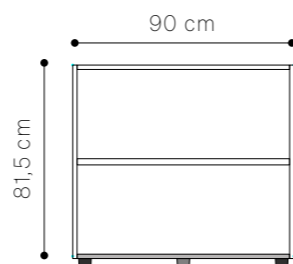

Cod. RCBSW0 £191.00 + VAT

Low open bookcase dim. 90x44.5x h.81.5 cm, structure panel thickness 18 mm, shelf panel thickness 25 mm.

Structure color  WH

## Low bookcase wooden doors with lock

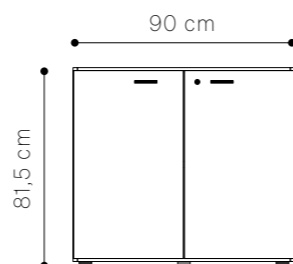

Cod. RCBSW0D

Door colors  O4B  O5Y  O6R  O7G £336.00 + VAT

Structure color  WH

O3W £278.00 + VAT

Dim. 90x46.3x h.81.5 cm, structure panel thickness 18 mm, shelf panel thickness 25 mm, door panel thickness 18 mm, metal wing hinges opening 110°, lock with extractable cylinder and white polypropylene handle.

## Medium open bookcase

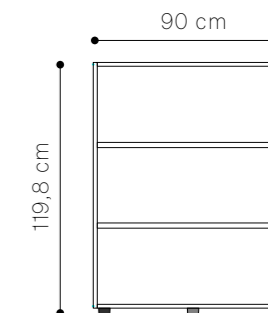

Cod. PCBSW0 £272.00 + VAT

Medium open bookcase dim. 90x44.5x h.119.8 cm, structure panel thickness 18 mm, shelf panel thickness 25 mm.

Structure color  WH

## Open medium bookcase with doors

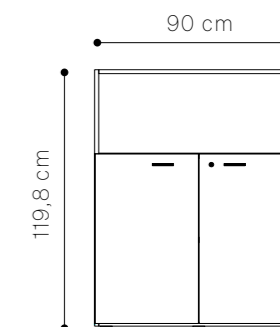

Cod. PCBSW0D2

Door colors  O4B  O5Y  O6R  O7G £416.00 + VAT

Structure color  WH

O3W £358.00 + VAT

Dim. 90x46.3x h.119.8 cm, structure panel thickness 18 mm, shelf panel thickness 25 mm, door panel thickness 18 mm, metal wing hinges opening 110°, lock with extractable cylinder and white polypropylene handle.

## Medium bookcase with doors

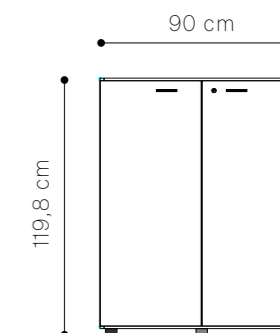

Cod. PCBSW0D

Door colors  O4B  O5Y  O6R  O7G £464.00 + VAT

Structure color  WH

O3W £379.00 + VAT

Dim. 90x46.3x h.119.8 cm. with two wooden doors, structure panel thickness 18 mm, shelf panel thickness 25 mm, door panel thickness 18 mm, metal wing hinges opening 110°, lock with extractable cylinder and white polypropylene handle.



Add color code to item code when ordering.

library

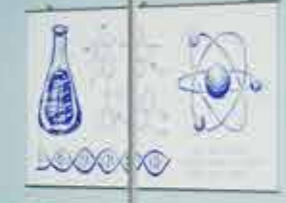



## Medium open bookcase

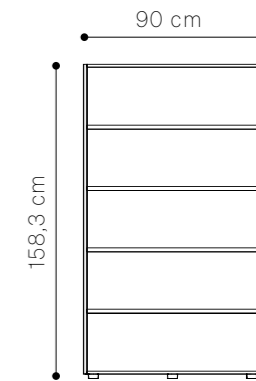

Cod. BCBSW0 £347.00 + VAT

Dim. 90×44,5x h.158,3 cm, structure panel thickness 18 mm, shelf panel thickness 25 mm.

Structure color ● WH

## Open medium bookcase with doors

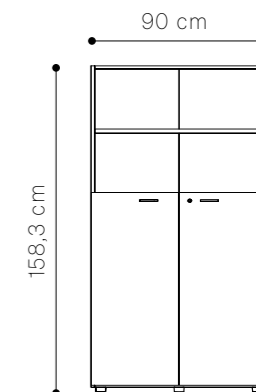

Cod. BCBSW0D2

Door colors ● O4B ● O5Y ● O6R ● O7G £492.00 + VAT

Structure color ● WH

● O3W £434.00 + VAT

Dim. 90×46,3x h.158,3 cm, structure panel thickness 18 mm, shelf panel thickness 25 mm, door panel thickness 18 mm, metal wing hinges opening 110°, lock with extractable cylinder and white polypropylene handles.

## Medium bookcase with 4 overlapping doors

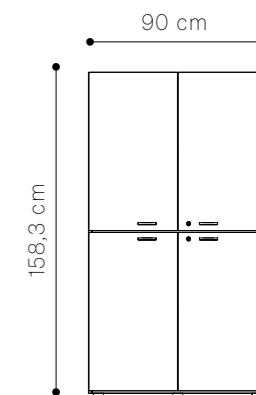

Cod. BCBSW02D2

Door colors ● O4B ● O5Y ● O6R ● O7G £645.00 + VAT

Structure color ● WH

● O3W £525.00 + VAT

Dim. 90×46,3x h.158,3 cm. with four wooden doors, structure panel thickness 18 mm, shelf panel thickness 25 mm, door panel thickness 18 mm, metal wing hinges opening 110°, lock with extractable cylinder and white polypropylene handles.

Add color code to item code when ordering.

## Medium open with 2 wooden doors

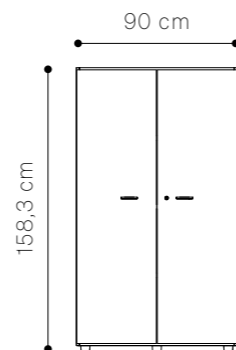

Cod. BCBSW0D  
 Door colors ● O4B ● O5Y ● O6R ● O7G £601.00 + VAT  
 Structure color ● WH ● O3W £493.00 + VAT

Dim. 90×46,3x h.158,3 cm with two wooden doors, structure panel thickness 18 mm, shelf panel thickness 25 mm, door panel thickness 18 mm, metal wing hinges opening 110°, lock with extractable cylinder and white polypropylene handles.

## Open high bookcase

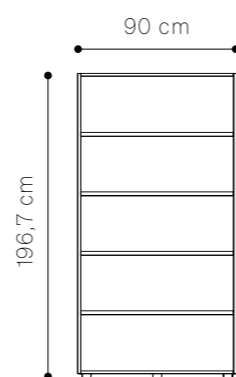

Cod. LCBSW0 £424.00 + VAT

Dim. 90×44,5x h.196,7 cm, structure panel thickness 18 mm, shelf panel thickness 25 mm.

Structure color ● WH

## Open high bookcase with doors on the lower part

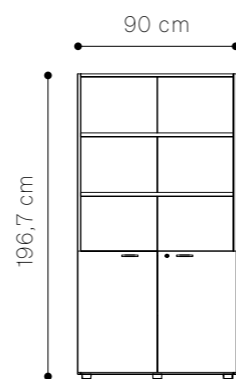

Cod. LCBSW0D2  
 Door colors ● O4B ● O5Y ● O6R ● O7G £567.00 + VAT  
 Structure color ● WH ● O3W £510.00 + VAT

Dim. 90×46,3x h.196,7 cm with two wooden doors, structure panel thickness 18 mm, shelf panel thickness 25 mm, door panel thickness 18 mm, metal wing hinges opening 110°, lock with extractable cylinder and white polypropylene handles.

## High bookcase with 4 overlapping doors, short doors lower

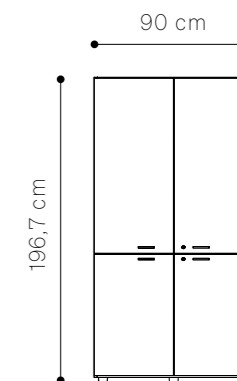

Cod. LCBSW02D2-3  
 Door colors ● O4B ● O5Y ● O6R ● O7G £760.00 + VAT  
 Structure color ● WH ● O3W £617.00 + VAT

Dim. 90×46,3x h.196,7 cm with two wooden doors, structure panel thickness 18 mm, shelf panel thickness 25 mm, door panel thickness 18 mm, metal wing hinges opening 110°, lock with extractable cylinder and white polypropylene handles.

## High bookcase with medium doors

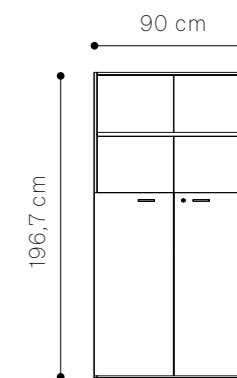

Cod. LCBSW0D3  
 Door colors ● O4B ● O5Y ● O6R ● O7G £615.00 + VAT  
 Structure color ● WH ● O3W £531.00 + VAT

Dim. 90×46,3x h.196,7 cm with two wooden doors, structure panel thickness 18 mm, shelf panel thickness 25 mm, door panel thickness 18 mm, metal wing hinges opening 110°, lock with extractable cylinder and white polypropylene handles.

## High bookcase with 4 overlapping doors, short doors upper

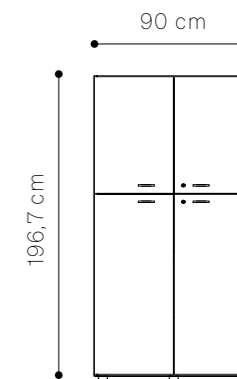

LCBSW02D3-2  
 Door colors ● O4B ● O5Y ● O6R ● O7G £769.00 + VAT  
 Structure color ● WH ● O3W £622.00 + VAT

Dim. 90×46,3x h.196,7 cm with two wooden doors, structure panel thickness 18 mm, shelf panel thickness 25 mm, door panel thickness 18 mm, metal wing hinges opening 110°, lock with extractable cylinder and white polypropylene handles.



## bookcase wooden doors with lock

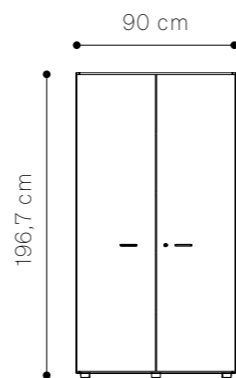

Cod. LCBSW0D

Door colors ● O4B ● O5Y ● O6R ● O7G **£771.00 + VAT**

Structure color ● WH

● O3W **£635.00 + VAT**

**Dim. 90x46,3x h.196,7 cm.** with two wooden doors, structure panel thickness 18 mm, shelf panel thickness 25 mm, door panel thickness 18 mm, metal wing hinges opening 110°, lock with extractable cylinder and white polypropylene handles.

## 45° double-sided corner bookcase

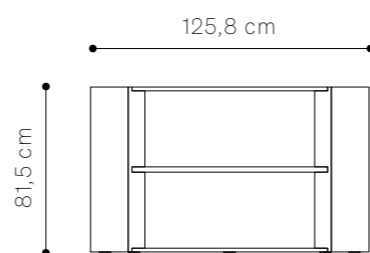

Cod. GCBSW0 **£551.00 + VAT**

Bookcase in chipboard **dim. 91.7/125.8 x44.5x h.81.5 cm**, structure panel thickness 18 mm, shelf panel thickness 25 mm.

Structure color ● WH

## Bookcase h120cm corner double-sided

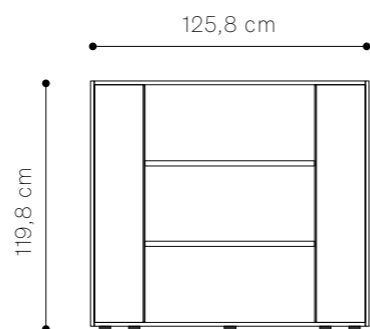

Cod. GCBSW1 **£782.00 + VAT**

Bookcase in chipboard **dim. 91.7/125.8 x44.5x h.119.8 cm**, structure panel thickness 18 mm, shelf panel thickness 25 mm.

Structure color ● WH

## Bookcase h158 cm corner double-sided

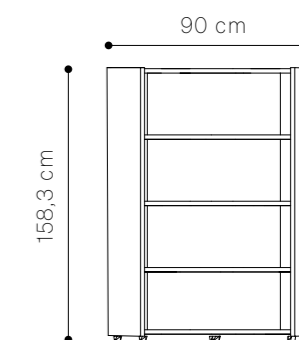

Cod. GCBSW2 **£989.00 + VAT**

Bookcase in melamine **dim. 91.7/125.8 x44.5x h.158.3 cm**, thickness of structure panels 18 mm, thickness of shelf panels 25 mm.

Structure color ● WH

## Bookcase h196 cm corner double-sided

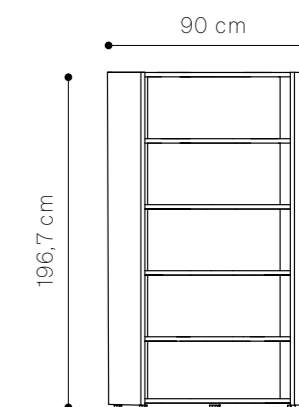

Cod. GCBSW3 **£1,195.00 + VAT**

Bookcase in melamine **dim. 91.7/125.8 x44.5x h.196.7 cm**, thickness of structure panels 18 mm, thickness of shelf panels 25 mm.

Structure color ● WH

## Wheel with brake for bookcases and lockers

Cod. CBWHCH04 **£33.00 + VAT**

Wheel with brake for wardrobes and lockers (p.u.d.) 75kg each (pack of 4 pieces).

Satin steel material





# Library Bookshelf System

The key word is versatility! With the new library bookcase systems you can furnish large multifunctional spaces, cultural centers, reading centers and much more. The versatility come from the modularity of these benches that are combined with cushions to provide comfortable seating in storage spaces. Self-supporting in 8/10 mm thick sheet metal of first choice DC01-UNI EN 10130 press-bent. The components of the structure have 2 mm rounded external edges in compliance with current safety standards. The shelves are structural and have a capacity of up to 50 kg (uniformly distributed load).

Standard dimensional and safety certifications for educational institutions:  
- CAM (minimum environmental criteria)



## innovation and reliability

The innovation of materials makes our bookcases **precious furnishing elements**



## Design and modularity

All modules have a width of 120 and a height of your choice of 45,82,120,160 and 200 cm, **combine them to create your perfect solution**, together with the bench module with coloured padded cushion!



## Metal bench

### 1 compartment h45 cm

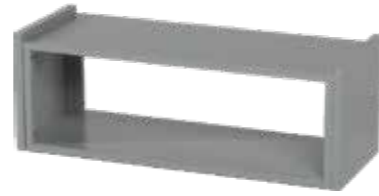

Cod. LMET45P £331.00 + VAT

Metal bench 1 compartment dim. 120x45xh45cm. Note: Always finish with cushion cod. LMETCS.

Structure colors

● RAL 9003	● RAL 7016	● RAL 7035
● 2006	● 3900	● 2008

## Metal bookcase

### 2 compartments h82 cm



Cod. LMET82 £423.00 + VAT

Metal bookcase, 2 compartments dim. 120x45xh82 cm. Note: always finish with top cod. LMETTOP.

Structure colors

● RAL 9003	● RAL 7016	● RAL 7035
● 2006	● 3900	● 2008

## Metal bookcase

### 3 compartments h120 cm



Cod. LMET120 £633.00 + VAT

Metal bookcase, 3 compartments dim. 120x45xh120 cm. Note: always finish with top cod. LMETTOP

Structure colors

● RAL 9003	● RAL 7016	● RAL 7035
● 2006	● 3900	● 2008

## Metal Bookcase

### 4 compartments h 160 cm



Cod. LMET160 £758.00 + VAT

Metal bookcase, 4 compartments dim. 120x45xh160 cm. Note: always finish with top cod. LMETTOP.

Structure colors

● RAL 9003	● RAL 7016	● RAL 7035
● 2006	● 3900	● 2008





## Metal bookcase

### 5 compartments h 200 cm



Cod. LMET200 £881.00 + VAT

Metal bookcase 5 compartments dim. 120x45x h.200 cm.

Structure colors

- RAL 9003
- RAL 7016
- RAL 7035
- 2006
- 3900
- 2008

## High bench module

### h 200 cm

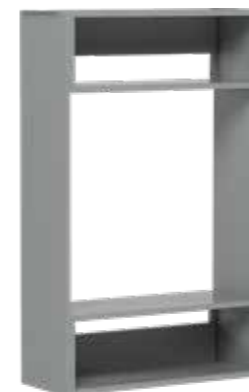

Cod. LMET200P £845.00 + VAT

High bench module dim. 120x45x h.200 cm. Note: always finish with top cod. LMETCS.

Structure colors

- RAL 9003
- RAL 7016
- RAL 7035
- 2006
- 3900
- 2008

Cod. LMETKITR £182.00 + VAT

Wheel frame kit for bench and bookcase modules dim. 120x45x h.8 cm

Colors

- RAL 9003
- RAL 7016
- RAL 7035
- 2006
- 3900
- 2008

Cod. LMETCS £179.00 + VAT

Cushions for bench modules dim. 120x45x h.3 cm

Colors

- Yellow
- Red
- Green
- Blue

Cod. LMETTOP £82.00 + VAT

Wooden tops for bookcases dim. 120x45x h.1,8 cm

Colors

- White
- Black
- Grey

Add color code to item code when ordering.





SMARTARREDA

# Lockers

Store documents and personal effects: combine elegance and practicality in a collection of lockers with a modern and essential design.

Standard dimensional and safety certifications for educational institutions:

- CAM (minimum environmental criteria)

Decree 23 June 2022

Ministry of Ecological Transition

- UNI EN 14073-2

- UNI EN 14073-3

- UNI EN 14074

- UNI 8601

- UNI 8606

- FSC

- E1 CLASS



# Design your space

Lock it safe, leave with confidence

Our lockers are designed to offer you maximum security and peace of mind. Thanks to durable materials and advanced locking systems, you can store your personal items without worries. Trust us for safe and convenient storage, wherever you are.

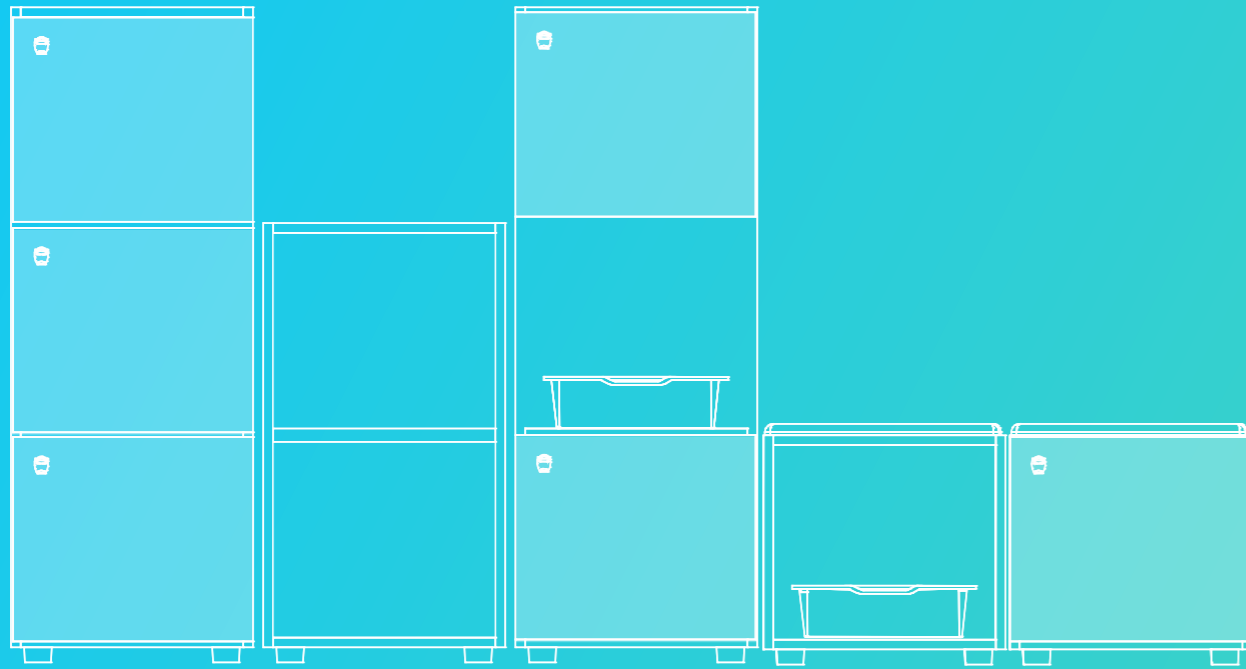

## Smart, simple, secure

Store documents  
and personal  
effects

Combining elegance and practicality in a collection of lockers with a modern and essential design. Standard locks and different types of heights, same level of security and efficiency.

### Overview

All components are supplied disassembled and packaged in a triple folding cardboard wrapping, with perimeter protection strips and for fillings. The corners are protected, where necessary, with shock-absorbent corner guards. The packaging is closed with adhesive tape and heat-sealed nylon strapping.

### Wood characteristics

Volume UNI EN 323: 1994	650 KG / m <sup>3</sup> ± 10%
Relative humidity UNI EN 322: 1994	5 - 13 %
Thickness tolerance UNI EN 324-1/1994	± 0.3 mm
24hours swelling UNI EN 317: 1994	15 %
Detachment of external layers UNI EN 311: 2003	0.8 Mpa
Static bending UNI EN 310: 1994	16 Mpa
Elasticity's module UNI EN 310: 1994	1600 Mpa
Screw extractions on the edges UNI EN 320: 1994	> 400 Mpa
Formaldehyde content UNI EN ISO 12460 -3 :2015	≤ a 3,5 mg H <sub>2</sub> CO (m <sup>2</sup> X H)

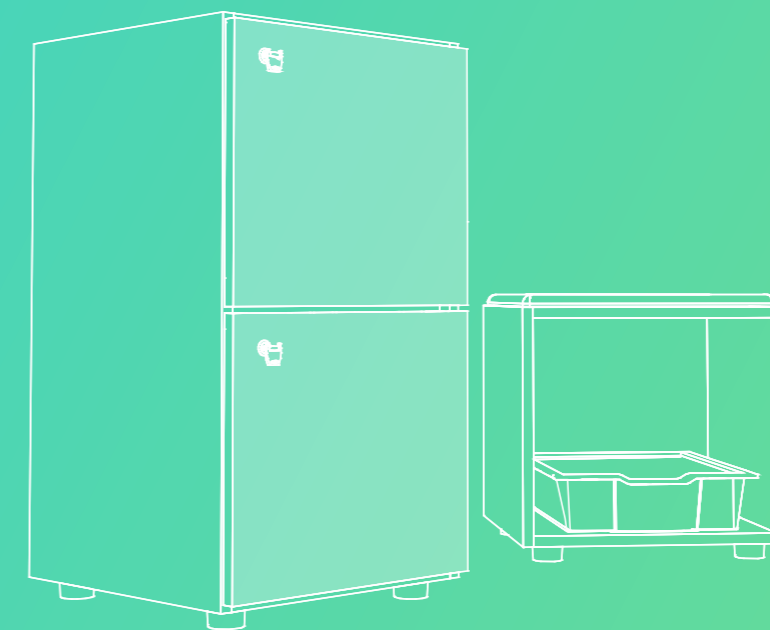
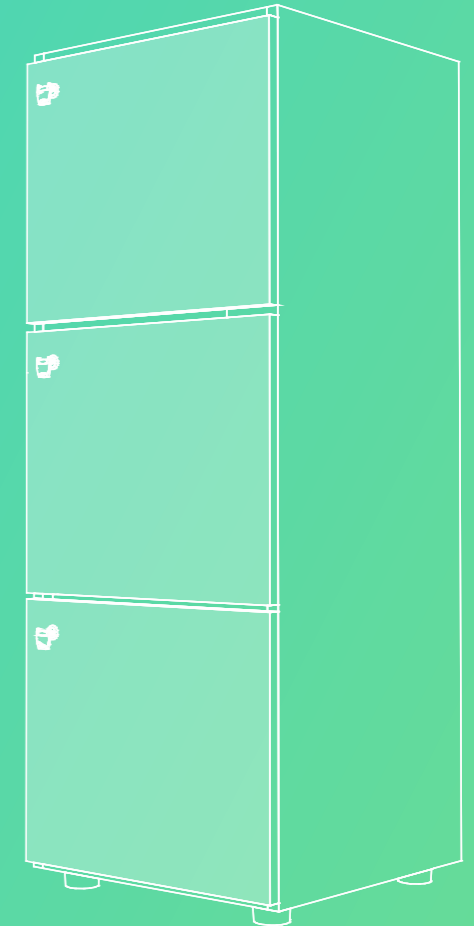
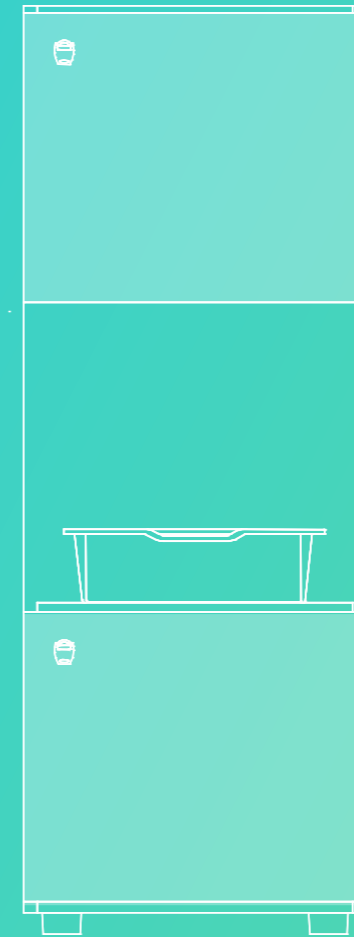



## Open locker 1 compartment

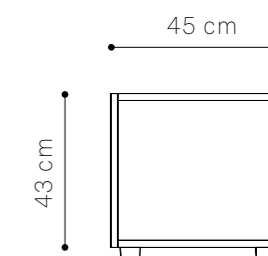

Cod. ALKSW0 £79.00 + VAT

Open locker 1 compartment in melamine **dim. 45×44.5x h.81.5 cm**, structure panel thickness 18 mm, shelf panel thickness 25 mm.

Structure color ● WH

## Open locker 2 compartment

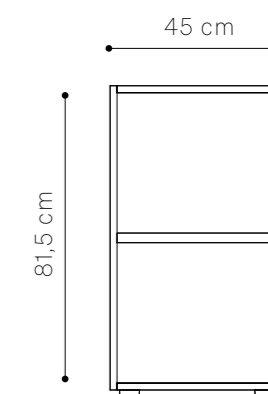

Cod. ALKSW01 £129.00 + VAT

Open locker 2 compartments in melamine **dim. 45×44.5x h.81.5 cm**, structure panel thickness 18 mm, shelf panel thickness 25 mm.

Structure color ● WH

## Open locker 3 compartment

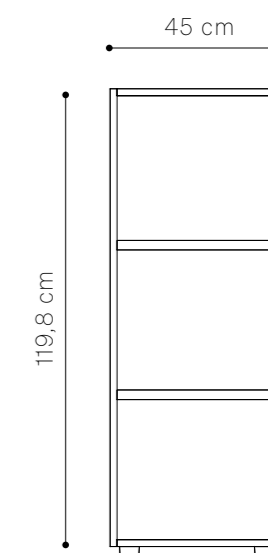

Cod. ALKSW02 £182.00 + VAT

Open locker 3 compartments in melamine **dim. 45×44.5x h.119.8 cm**, structure panel thickness 18 mm, shelf panel thickness 25 mm.

Structure color ● WH

Add color code to item code when ordering.

# Open locker

## 4 compartment

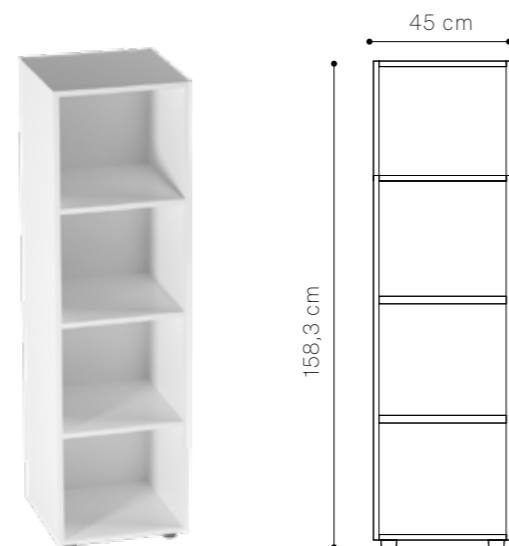

Cod. ALKSW03 £227.00 + VAT

Open locker 4 compartments in melamine dim. 45x44.5x h.158.3 cm, thickness of structure panels 18 mm, thickness of shelf panels 25 mm

Structure color ● WH

# Cover top



Cod. LKPSH

Additional adjustable shelf

Dim. 41,2 x 40,6 x 1,8 h

Color ● WH

£19.00 + VAT



Cod. LK1TOP45

cover top for 1 locker

Dim. side 45

Color ● WH

£24.00 + VAT



Cod. LK2TOP90

cover top for 2 locker

Dim. side 90

Color ● WH

£41.00 + VAT



Cod. LK3TOP135

cover top for 3 locker

Dim. side 135

Color ● WH

£57.00 + VAT



Cod. LK4TOP180

cover top for 4 locker

Dim. side 180

Color ● WH

£74.00 + VAT





Cod. LDNK

Colored door with standard lock

Door colors ● 1A ● 2A ● 3A ● 4A **£56.00 + VAT**  
● 7A **£39.00 + VAT**



Cod. LK01MKCL

1 master key + 1 cylinder extraction key

**£34.00 + VAT**



Cod. 110586735

Pair of tray guides

**Compatible with TS01/TL01**  
**applicable only on lockers**

**£23.00 + VAT**



Cod. TS01

Coloured small tray

**£13.00 + VAT**

Small polypropylene tray dim. 31.2 x 43 x h 7.5 cm,  
**applicable only to the L45 module in the absence of doors**



Colors ● B ● G ● R ● Y

Cod. TL01

Coloured big tray

**£26.00 + VAT**

Large polypropylene tray dim. 31.2 x 43 x h 22.5 cm,  
**applicable only to the L45 module in the absence of doors**



Colors ● B ● G ● R ● Y



Cod. CBWHCH04

Wheel with brake for furniture and lockers ( p.u.d. ) 75 kg each ( pack of 4 pcs )

£33.00 + VAT



Cod. LKNAT1UT10

from 1 to 10 Adhesive numbers for lockers £21.00 + VAT

Cod. LKNAT1UT20

from 11 to 20

Cod. LKNAT1UT30

from 21 to 30

Cod. LKNAT1UT40

from 31 to 40

Cod. LKNAT1UT50

from 41 to 50



Cod. LKPL45SPNI

Cushion L45 cm in faux leather thickness 5 cm with zip

£46.00 + VAT

Colors  01  02  03  04  05  06



Cod. LKPL90SPNI

Cushion L90 cm in faux leather thickness 5 cm with zip

£76.00 + VAT

Colors  01  02  03  04  05  06





SMARTARREDA

# Pouf and lounge seats

Furnishing spaces with style without sacrificing comfort: the lounge collection by Motris offers a range of poufs and lounge seats, in perfect balance between design and comfort. Welcome to the 'next comfort experience.

Standard dimensional and safety certifications for educational institutions:

- CAM (minimum environmental criteria)

Decree 23 June 2022

Ministry of Ecological Transition

- UNI EN 9175 (Class 11M)

- 11M CLASS

- E1 CLASS

# Lounge collection

Not ordinary comfort

Create endless combinations of colors and shapes with our series of poufs designed specifically for schools. The design is practical and safe and prevents any type of fall or injury at school.

**All the upholstered items are in imitation leather/fireproof fabric certified in class 11M.**

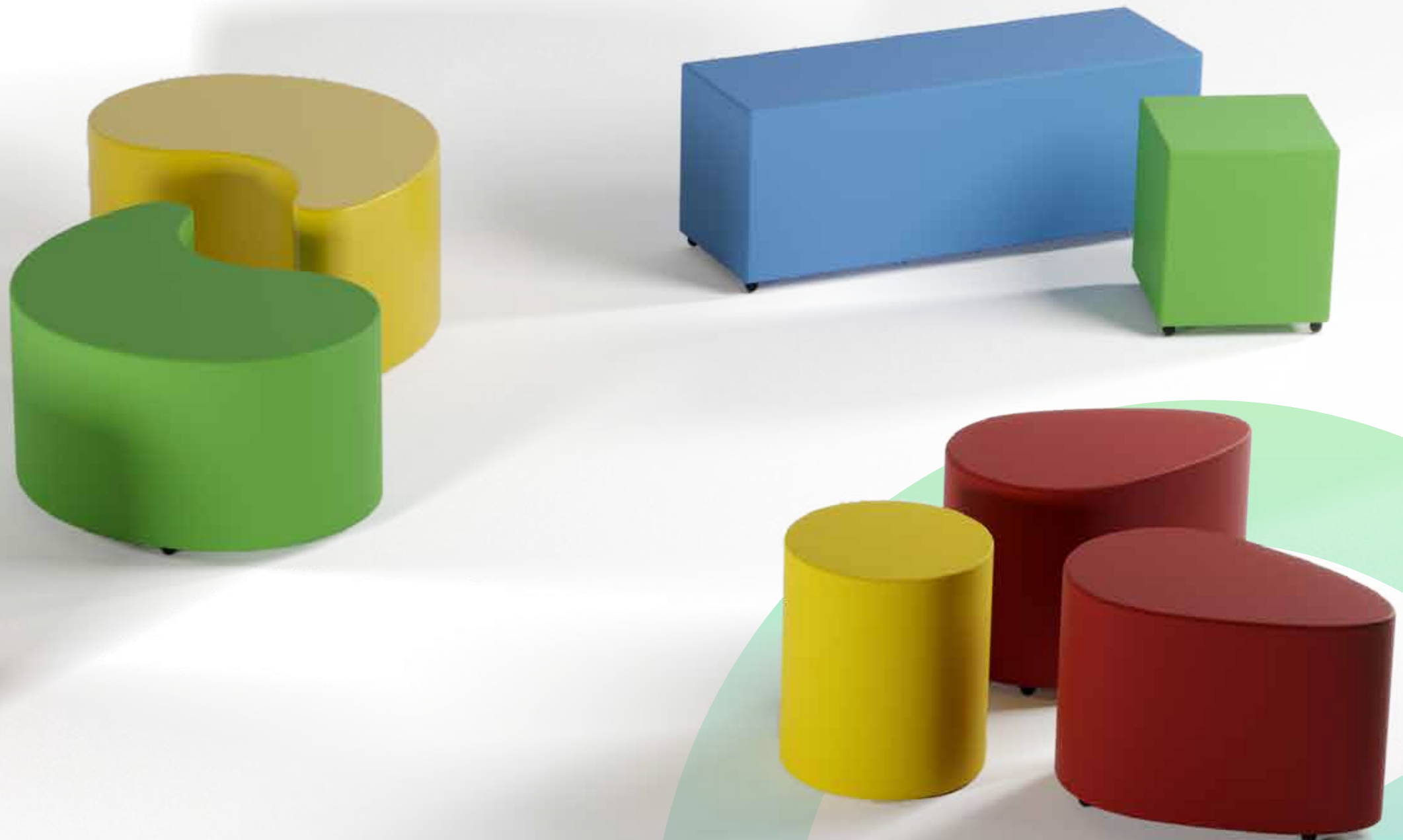



## Cube pouf

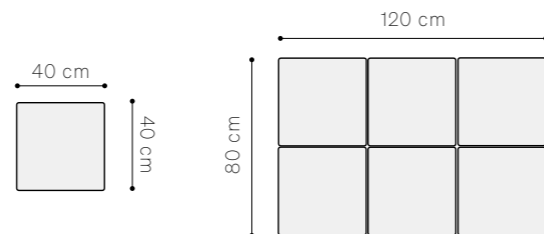

Soft square seat, internal load-bearing structure in low-formaldehyde emission particle board (Class E1) with fixed black PVC feet. Padding in high-density polyurethane foam, 10 mm thick, imitation leather upholstery, available in six colors.

**Cod. PSRT40SPNI £142.00 + VAT** Cube pouf 40×40×h.46 cm padded removable cover, covered in colored faux leather.

Colors ● 01 ● 02 ● 03 ● 04 ● 05 ● 06

## Rectangular 160 pouf

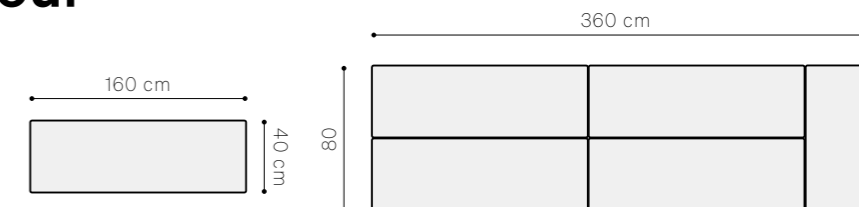

Rectangular soft seat L=160 cm, internal load-bearing structure in particle board with low formaldehyde emission (Class E1) with fixed feet in black PVC. Padding in high-density polyurethane foam, thickness 10 mm, faux leather covering, available in six colors.

**Cod. PSRT160SPNI £346.00 + VAT** Pouf dim. 160×40×h.46 cm padded removable cover, covered in colored faux leather.

Colors ● 01 ● 02 ● 03 ● 04 ● 05 ● 06

## Rectangular 80 pouf

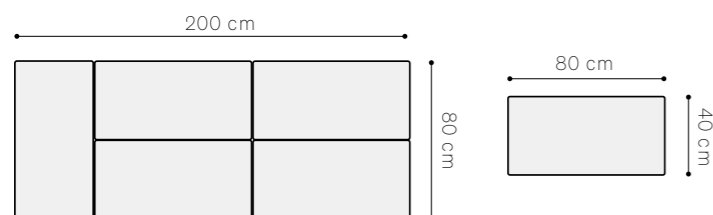

Rectangular soft seat, internal load-bearing structure in low formaldehyde emission particle board (Class E1) with fixed black PVC feet. Padding in high-density polyurethane foam, 10 mm thick, faux leather upholstery, available in six colours



**Pouf dim. 80×40×h.46 cm** padded removable cover, covered in colored faux leather.

**Cod. PSRT80SPNI £215.00 + VAT**

Colors ● 01 ● 02 ● 03 ● 04 ● 05 ● 06

## Rectangular 80 with backrest pouf

Rectangular pouf with removable padded backrest, internal load-bearing structure in low formaldehyde emission wood particle board (Class E1) with fixed black PVC feet. Padding in high-density polyurethane foam, thickness 10 mm, faux leather covering, available in six colors.



Rectangular 80 with backrest pouf dim. 80×40/60 x h.46/76 cm **Cod. PSRTWS80SPNI £460.00 + VAT**

Colors ● 01 ● 02 ● 03 ● 04 ● 05 ● 06

## Rectangular 120 pouf

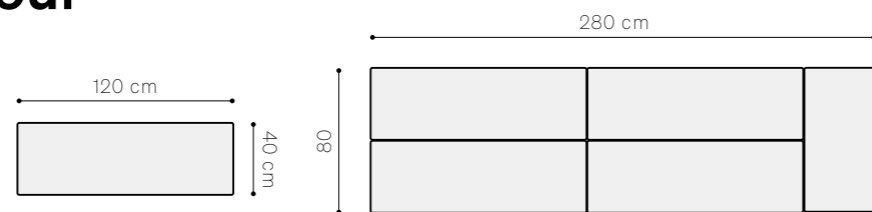

Rectangular soft seat L=120 cm, internal load-bearing structure in particle board with low formaldehyde emission (Class E1) with fixed feet in black PVC. Padding in high-density polyurethane foam, thickness 10 mm, faux leather covering, available in six colors.

**Cod. PSRT120SPNI £273.00 + VAT** Pouf dim. 120×40×h.46 cm padded removable cover, covered in colored faux leather.

Colors ● 01 ● 02 ● 03 ● 04 ● 05 ● 06

## Rectangular 120 with backrest pouf



Rectangular pouf with removable padded backrest, internal load-bearing structure in low formaldehyde emission wood particle board (Class E1) with fixed black PVC feet. Padding in high density polyurethane foam, thickness 10 mm, faux leather covering, available in six colours.

**Cod. PSRTWS120SPNI £603.00 + VAT** Rectangular 120 with backrest pouf dim. 120×40/60 x h.46/76 cm

Colors ● 01 ● 02 ● 03 ● 04 ● 05 ● 06



## Rectangular 160 with backrest pouf

Rectangular pouf with removable padded backrest, internal load-bearing structure in low formaldehyde emission wood particle board (Class E1) with fixed black PVC feet. Padding in high density polyurethane foam, thickness 10 mm, faux leather covering, available in six colours.

Cod. PSRTWS160SPNI £704.00 + VAT Rectangular 160 with backrest pouf dim. 160x40/60 x h.46/76 cm

Colors ● 01 ● 02 ● 03 ● 04 ● 05 ● 06

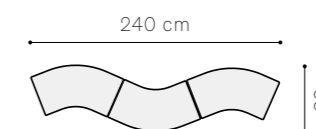
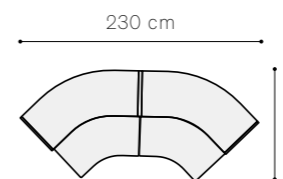
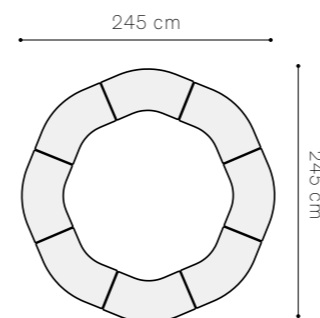

## 45° angled corner pouf



Soft 45° corner seat, internal load-bearing structure in low formaldehyde emission particle board (Class E1) with fixed black PVC feet. Padding in high-density polyurethane foam, 10 mm thick, faux leather upholstery, available in six colors.

Dim. 90/60x40x h.46 cm padded removable cover, covered in colored faux leather. Cod. PSAG45SPNI £235.00 + VAT

Colors ● 01 ● 02 ● 03 ● 04 ● 05 ● 06

## 90° angled corner pouf

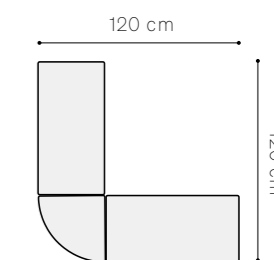
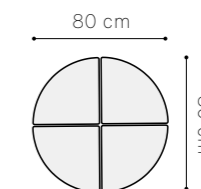
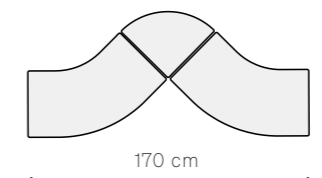

Soft 90° corner seat, internal load-bearing structure in low formaldehyde emission wood particle board (Class E1) with fixed black PVC feet. Padding in high-density polyurethane foam, 10 mm thick, imitation leather upholstery, available in six colors.

Cod. PSAG90SPNI £261.00 + VAT Dim. 40x40x h.46 cm padded removable cover, covered in colored faux leather.

Colors ● 01 ● 02 ● 03 ● 04 ● 05 ● 06

Add color code to item code when ordering.

## Hexagonal pouf

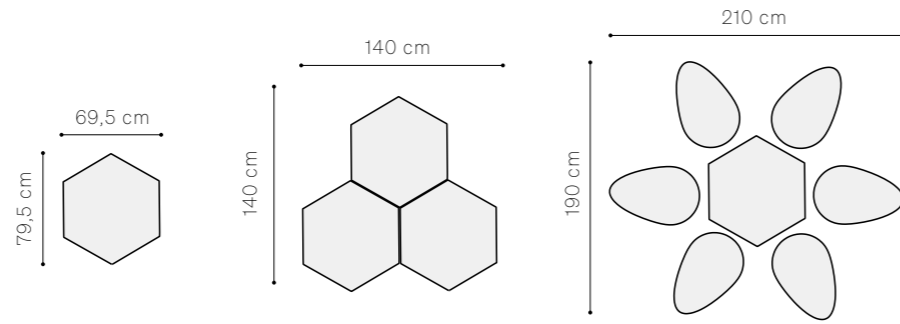

Soft hexagonal seat, internal load-bearing structure in low formaldehyde emission wood particle board (Class E1) with fixed black PVC feet. Padding in high-density polyurethane foam, 10 mm thick, faux leather upholstery, available in six colors.

Cod. PSDTXXSPNI £278.00 + VAT Dim.79,5×69,5xh.46 cm padded removable cover, covered in colored faux leather.

Colors ● 01 ● 02 ● 03 ● 04 ● 05 ● 06

## Comma pouf

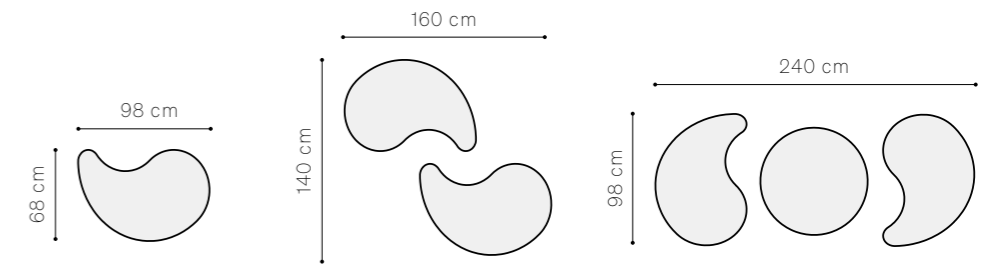

Soft comma seat, internal load-bearing structure in low formaldehyde emission wood particle board (Class E1) with fixed black PVC feet. Padding in high-density polyurethane foam, 10 mm thick, faux leather upholstery, available in six colors.

Cod. PSVRSPNIW £412.00 + VAT dim.79,5×69,5xh.46 cm padded removable cover, covered in colored faux leather.

Colors ● 01 ● 02 ● 03 ● 04 ● 05 ● 06

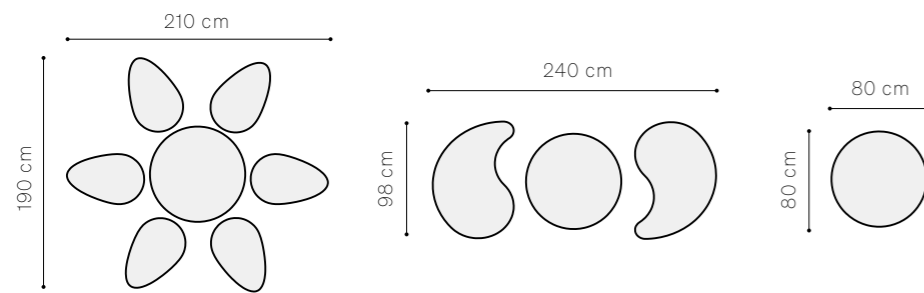

## Round pouf



Soft circular seat, internal load-bearing structure in low formaldehyde emission wood particle board (Class E1) with fixed black PVC feet. Padding in high-density polyurethane foam, 10 mm thick, faux leather upholstery, available in six colours.

Dim. Ø80 x h.46 cm padded removable cover, covered in colored faux leather.

Cod. PSTD80SPNI £242.00 + VAT

Colors ● 01 ● 02 ● 03 ● 04 ● 05 ● 06

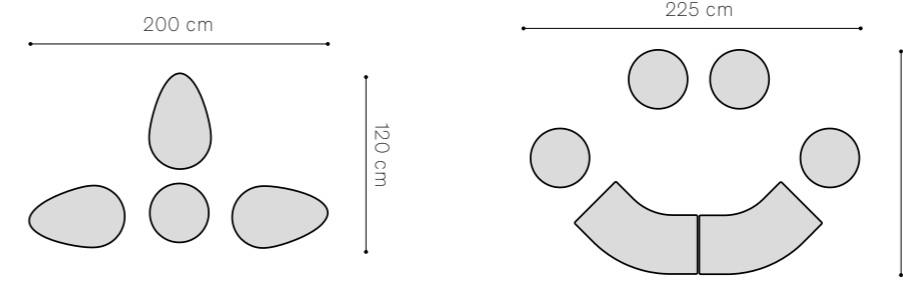

## Round pouf



Soft circular seat, internal load-bearing structure in low formaldehyde emission wood particle board (Class E1) with fixed black PVC feet. Padding in high-density polyurethane foam, 10 mm thick, faux leather upholstery, available in six colours.

Round pouf dim. Ø40 x h.46 cm padded removable cover, covered in colored faux leather.

Cod. PSTD40SPNI £131.00 + VAT

Colors ● 01 ● 02 ● 03 ● 04 ● 05 ● 06

## Drop pouf

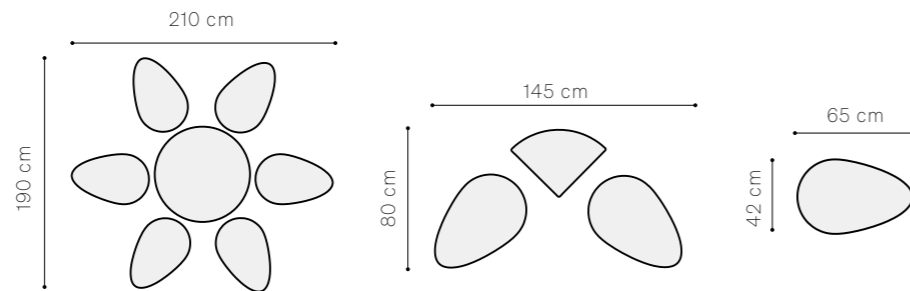

Soft drop seat, internal load-bearing structure in low formaldehyde emission wood particle board (Class E1) with fixed black PVC feet. Padding in high-density polyurethane foam, 10 mm thick, faux leather upholstery, available in six colours.

Cod. PSGCSPNIW £303.00 + VAT DROP Pouf dim. 65×42x h.46 cm padded removable cover, covered in colored faux leather.

Colors ● 01 ● 02 ● 03 ● 04 ● 05 ● 06

## Wheeled round pouf

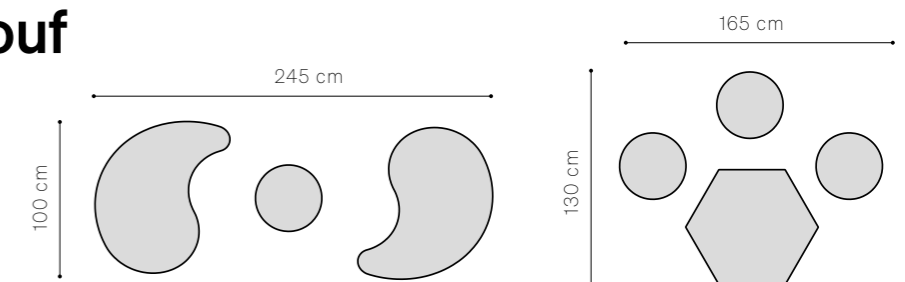

Soft round seat with wheels, internal load-bearing structure in low formaldehyde emission wood particle board (Class E1) with fixed black PVC feet. Padding in high-density polyurethane foam, 10 mm thick, faux leather upholstery, available in six colours.

Cod. PSTD40SPNIW £136.00 + VAT Dim.Ø40xh.46 cm padded removable cover, covered in colored faux leather.

Colors ● 01 ● 02 ● 03 ● 04 ● 05 ● 06



## Super Soft bag

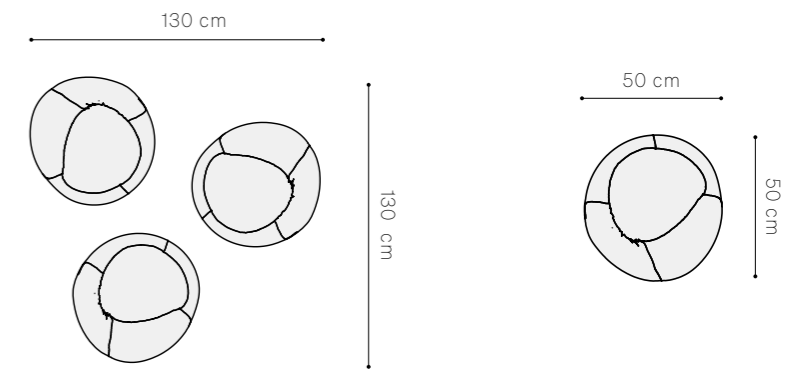

Cod. MSFSC50 £251.00 + VAT

Removable beanbag cushion available in 4 colors, fireproof fabric covering, size Ø50 with non-slip bottom

Colors ● 03 ● 04 ● 05 ● 06

## Soft bag

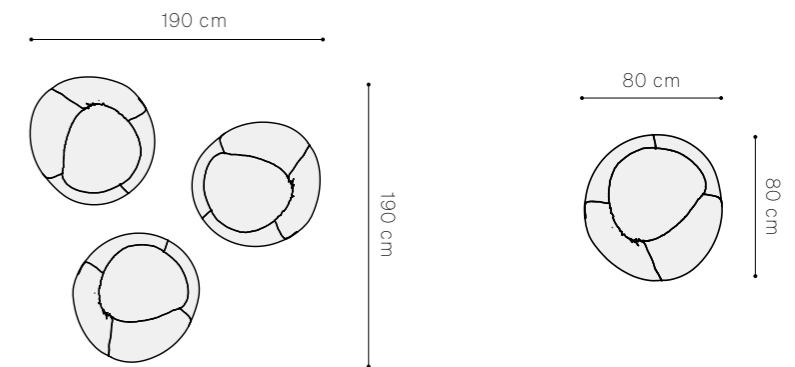

Cod. SFSC80TXI £366.00 + VAT

Bean bag chair with removable cover available in 4 colours, fireproof fabric covering, size Ø80

Colors ● 03 ● 04 ● 05 ● 06





SMARTARREDA

# Debate

A space for dialogue, between design and comfort: the stands and poufs of the debate collection are designed to furnish every setting with style.

Making every participant feel at ease, free to participate actively without missing any step of the discussion: our debate collection ensures maximum comfort.

# Debate collection

The comfy way to have a talk

*Standard dimensional and safety  
certifications for educational institutions:*

- CAM (minimum environmental criteria)

- E1 CLASS

- 11M CLASS (valid only for the 60  
and 160 benches)





## Grandstand on wheels



Cod. DBTR4P130 £2,171.00 + VAT

Tribune for debate on wheels, side compartments, 4 seats (optional cushions), rear compartments and folding desk. Dim. 130×90×100h

Structure ● WH Handles ● WH Tubular

01 ● RAL 9003 02 ● RAL 7035 03 ● RAL 1023  
04 ● RAL 3002 05 ● RAL 5014 06 ● RAL 6021

Note: At the end of the tribune article add the color code of the melamine chipboard panels, the metal tubular and the handle you intend to purchase.



## Accessories for grandstands

Cod. LKPL45SPNI Cushion L45 cm in faux leather 5 cm thick with zip £46.00 + VAT

Colors ● 01 ● 02 ● 03 ● 04 ● 05 ● 06



Cod. TSDB01 Small polypropylene tray complete with metal guides. Dim. 30×42x10 cm £23.00 + VAT

Color ● 01



Cod. TLDB01 Large polypropylene tray complete with metal guides. Dim. 30×42x23 cm £42.00 + VAT

Color ● 01



Add color code to item code when ordering.



## Debate bench internal side 60

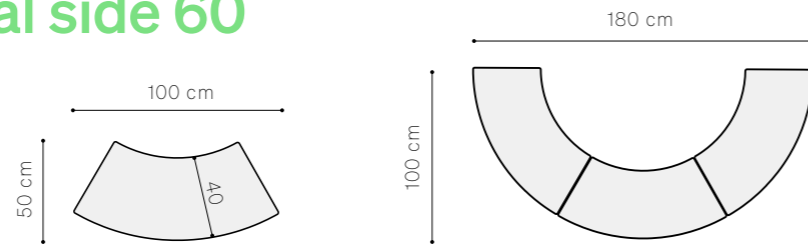

Soft corner seat side int.60 cm with padding in high density polyurethane foam 30 kg/m<sup>3</sup>, faux leather covering available in six colors, allows infinite configurations and combined with the pouf debate side int. 160 allows you to create an innovative semicircular configuration.

Cod. PSDT35SPNI £374.00 + VAT

CURVED PADDED BENCH internal side 60 external side 100×40x h.35 cm padded, covered in removable coloured imitation leather with non-slip bottom.

Colors ● 01 ● 02 ● 03 ● 04 ● 05 ● 06

## Debate bench internal side 160

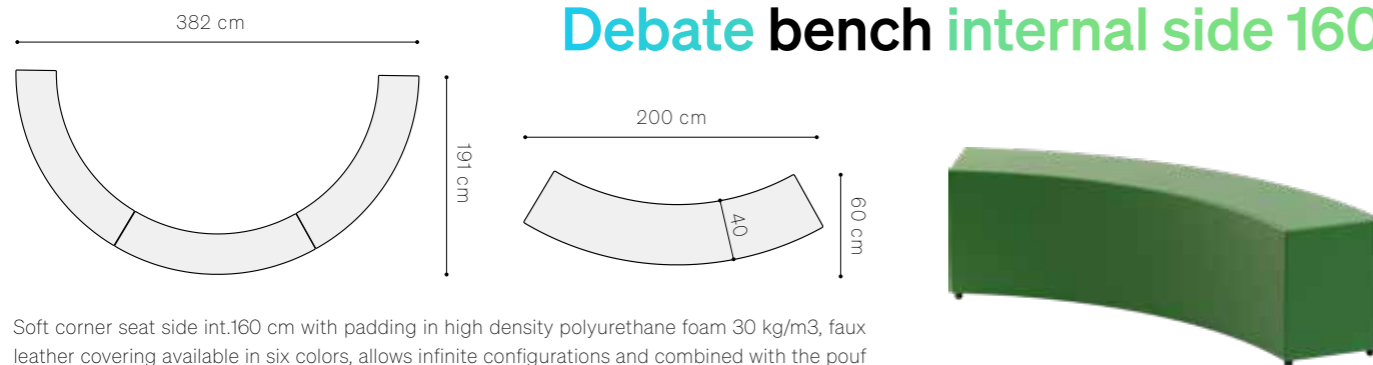

Soft corner seat side int.160 cm with padding in high density polyurethane foam 30 kg/m<sup>3</sup>, faux leather covering available in six colors, allows infinite configurations and combined with the pouf debate side int. 160 allows you to create an innovative semicircular configuration.

Cod. PSDT50SPNI £601.00 + VAT

CURVED PADDED BENCH internal side 160 external side 200×40x h.50 cm padded, covered in removable coloured faux leather with non-slip bottom.

Colors ● 01 ● 02 ● 03 ● 04 ● 05 ● 06

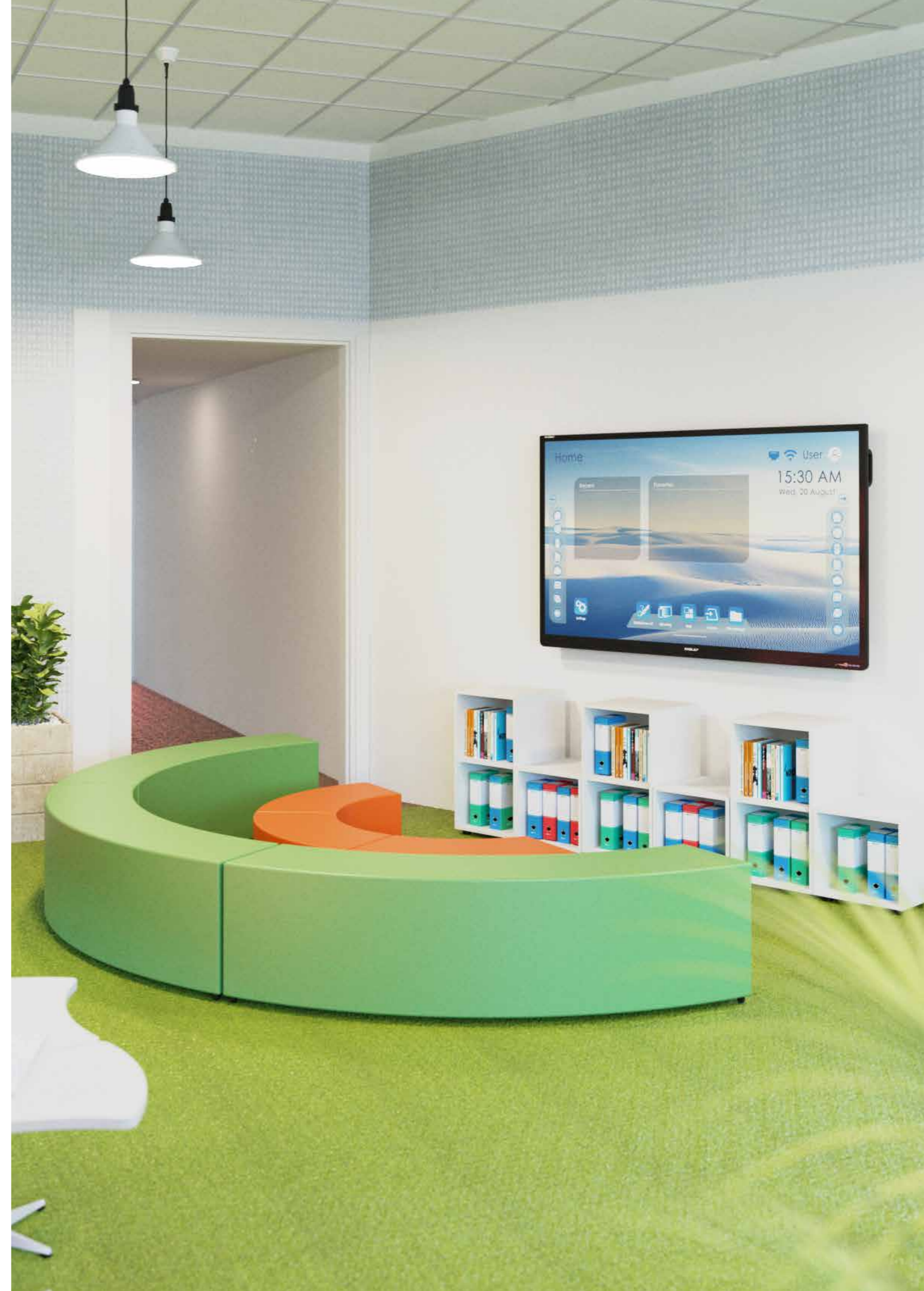
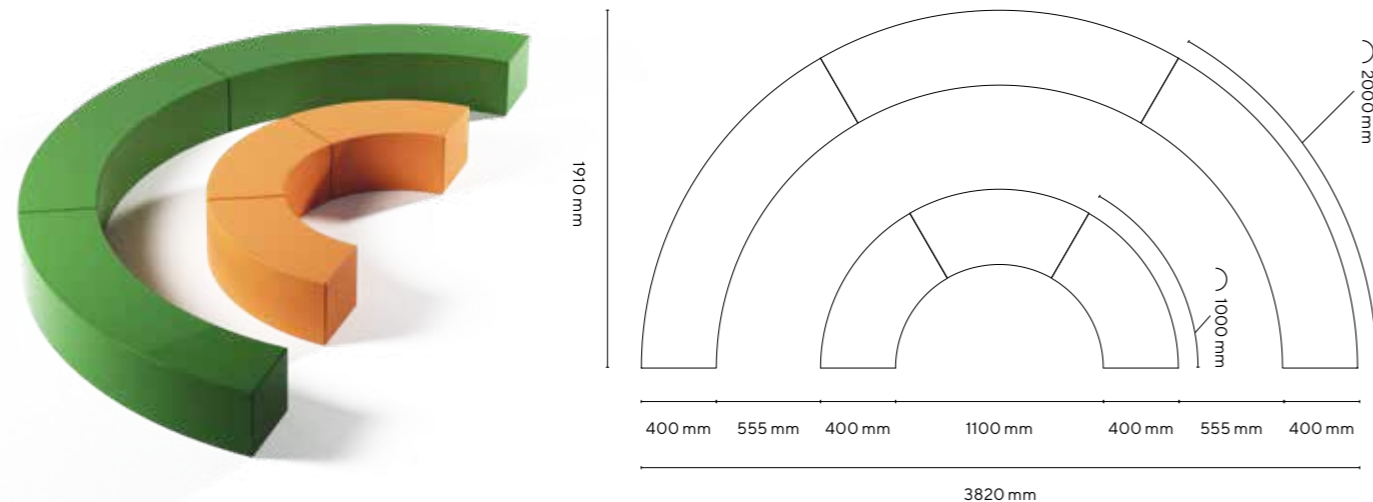



SMARTARREDA

# Sound-absorbing panels

Panels with light lines and a design that combines lightness with elegance. Designed for maximum sound absorption performance and the main feature of "separating" without dividing. The ability of these panels consists in creating divisions capable of forming functional spaces, adapting to every space requirement.

Standard dimensional and safety certifications for educational institutions:

- CAM (minimum environmental criteria)

Decree 23 June 2022

Ministry of Ecological Transition



# Reduce noise, increase harmony

## Acoustic wellbeing in every color

Choose from a wide range of alternatives, geometric shapes and bright or neutral colors: each panel is an opportunity to design quieter, more beautiful and more welcoming environments. It combines aesthetics and acoustic well-being in a single solution with a strong visual impact. **Our panels are available in white fiber or covered in fabric on one side or both sides.**

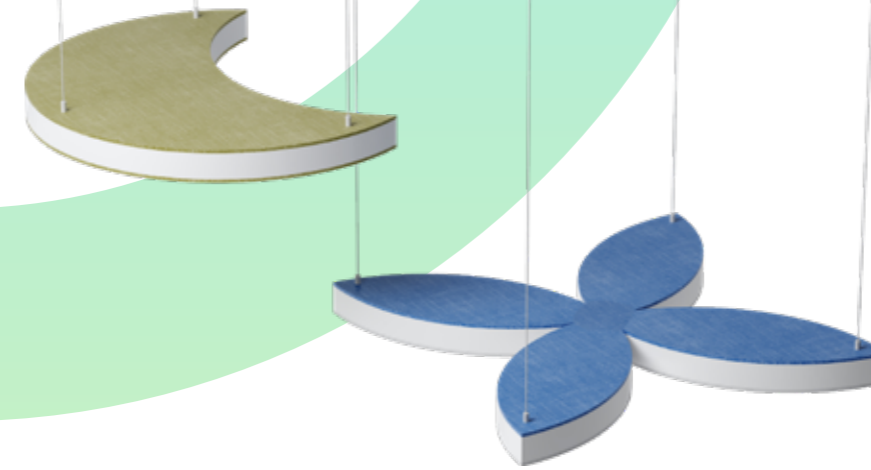

## Acoustic panels

# Acoustic performance, decorative soul

Our acoustic panels represent the perfect synthesis between design and functionality. Made in different shapes and colors, they adapt elegantly to any environment, transforming walls and ceilings into decorative elements capable of improving sound comfort. Thanks to their extreme versatility, they can be installed on the wall for an integrated and refined effect, or suspended from the ceiling horizontally or vertically, becoming architectural elements that define the space and reduce reverberation. Ideal for offices, meeting rooms, schools, restaurants and domestic environments, the panels give character to the environments while significantly improving the quality of listening and studying in the classroom.



## Square sound-absorbing panel



Sound-absorbing panel square shape available in 6 colors Dim. 60×60x h 4cm  
**NB. The panel covered on both sides is usable only for vertical suspended use.**

### White Fiber Sound-Absorbing Panel | (Pack of 4)

Cod. PAQUADRO £146.00 + VAT

Colors  01

### Sound-absorbing panel in colored fabric coated on one side | (Pack of 4)

Cod. PAQUADRO1L £296.00 + VAT

Colors  02  03  04  05  06  07

### Sound-absorbing panel in colored fabric coated on two sides | (Pack of 4)

Cod. PAQUADRO2L £415.00 + VAT

Colors  02  03  04  05  06  07

## Circular sound-absorbing panel



Sound-absorbing panel of circular shape available in 6 colors Diameter 60cm x h 4cm  
**NB. The panel covered on both sides is usable only for vertical suspended use.**

### White Fiber Sound-Absorbing Panel | (Pack of 4)

Cod. PATONDO £327.00 + VAT

Colors  01

### Sound-absorbing panel in colored fabric coated on one side | (Pack of 1)

Cod. PATONDO1L £166.00 + VAT

Colors  02  03  04  05  06  07

### Sound-absorbing panel in colored fabric coated on two sides | (Pack of 1)

Cod. PATONDO2L £233.00 + VAT

Colors  02  03  04  05  06  07

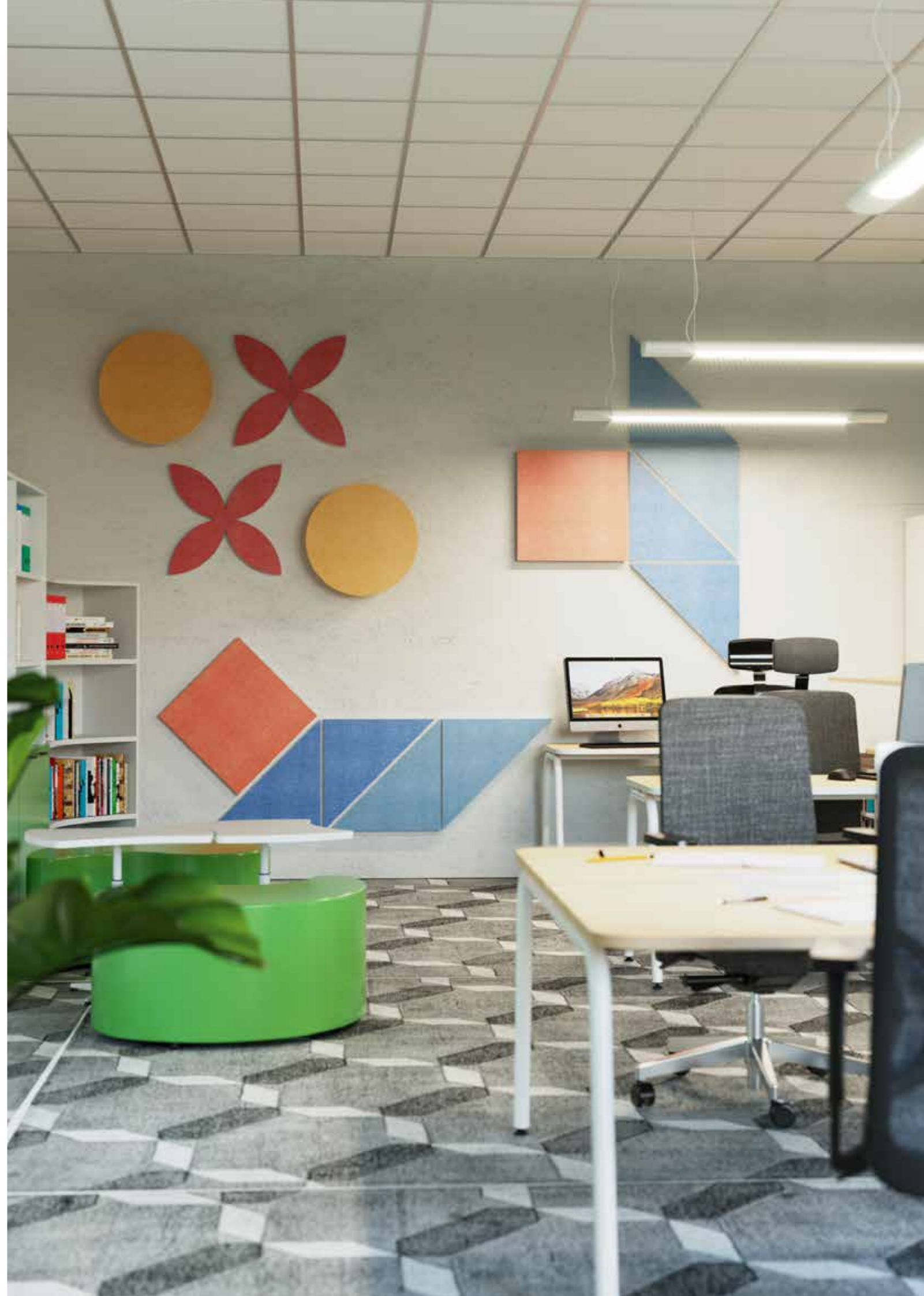



## 45° curved sound-absorbing panel



Sound absorbing panel  
45° curved shape  
available in 6 colors  
size 39×43x h 4 cm.

### White Fiber Sound-Absorbing Panel | (Pack of 4)

Cod. PACURVO £423.00 + VAT

Colors ● 01

Sound-absorbing panel in colored fabric  
coated on one side | (Pack of 1)

Cod. PACURVO1L £216.00 + VAT

Colors ● 02 ● 03 ● 04 ● 05 ● 06 ● 07

## Half-moon sound-absorbing panel



Sound absorbing panel  
half moon shaped  
available in 6 colors  
size 60×45 x h 4 cm.

### White Fiber Sound-Absorbing Panel | (Pack of 4)

Cod. PALUNA £423.00 + VAT

Colors ● 01

Sound-absorbing panel in colored fabric  
coated on one side | (Pack of 1)

Cod. PALUNA1L £216.00 + VAT

Colors ● 02 ● 03 ● 04 ● 05 ● 06 ● 07

## Petal sound-absorbing panel



Sound absorbing panel  
in the shape of petals  
available in 6 colors  
size 60×60xh 4 cm.

### White Fiber Sound-Absorbing Panel | (Pack of 4)

Cod. PAPETALI £423.00 + VAT

Colors ● 01

Sound-absorbing panel in colored fabric  
coated on one side | (Pack of 1)

Cod. PAPETALI1L £216.00 + VAT

Colors ● 02 ● 03 ● 04 ● 05 ● 06 ● 07

Add color code to item code when ordering.

## Triangular sound-absorbing panel



### White Fiber Sound-Absorbing Panel | (Pack of 4)

Cod. PATRIANGOLO £189.00 + VAT

Colors ● 01

### Sound-absorbing panel in colored fabric coated on one side | (Pack of 2)

Cod. PATRIANGOLO1L £216.00 + VAT

Colors ● 02 ● 03 ● 04 ● 05 ● 06 ● 07

### Sound-absorbing panel in colored fabric coated on two sides | (Pack of 2)

Cod. PATRIANGOLO2L £302.00 + VAT

Colors ● 02 ● 03 ● 04 ● 05 ● 06 ● 07

Triangular sound-absorbing panel available in 6 colors  
Size: 60×60xH 4 cm

**NB. The panel covered on both sides is usable only for vertical suspended use.**

Add color code to item code when ordering.

## Accessories



Cod. PAKITO

### Horizontal ceiling suspension kit

£38.00 + VAT

Horizontal baffle fixing, the panel is prepared with 2 holes to be mounted with this steel cable kit

**NB. Order 2 kits for each panel**



Cod. PAKITS

### Vertical ceiling suspension kit

£38.00 + VAT

Complete kit of steel accessories including screws and washers for fixing the panel suspended from the ceiling



Cod. PAKITP

### Kit of 2 hooks for wall fixing

£12.00 + VAT

Screw and hook excluded fisher for fixing the panel to the wall

**NB. If there is no possibility of making holes in the wall, you can use silicone or other types of suitable adhesives.**

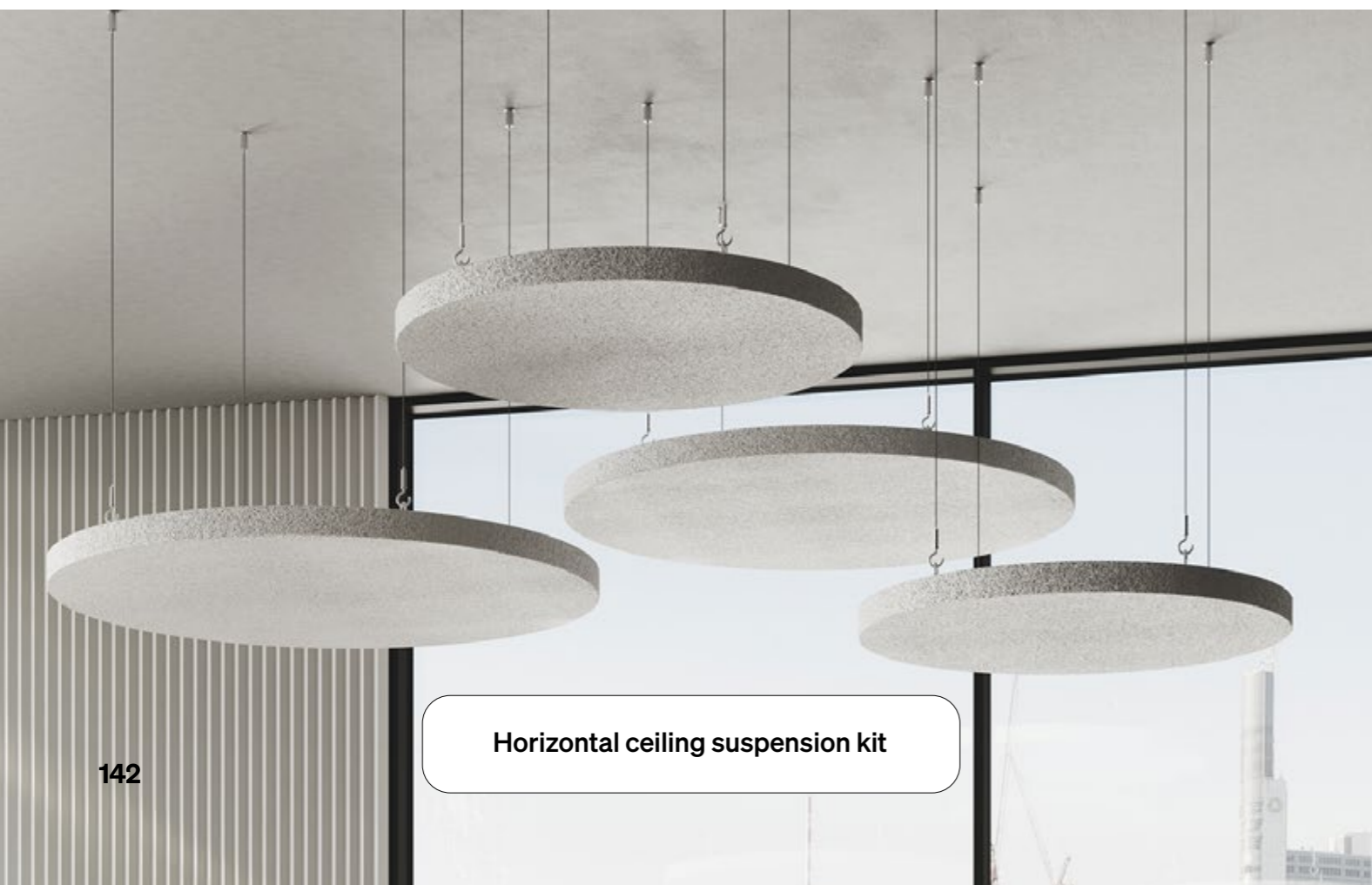

Horizontal ceiling suspension kit

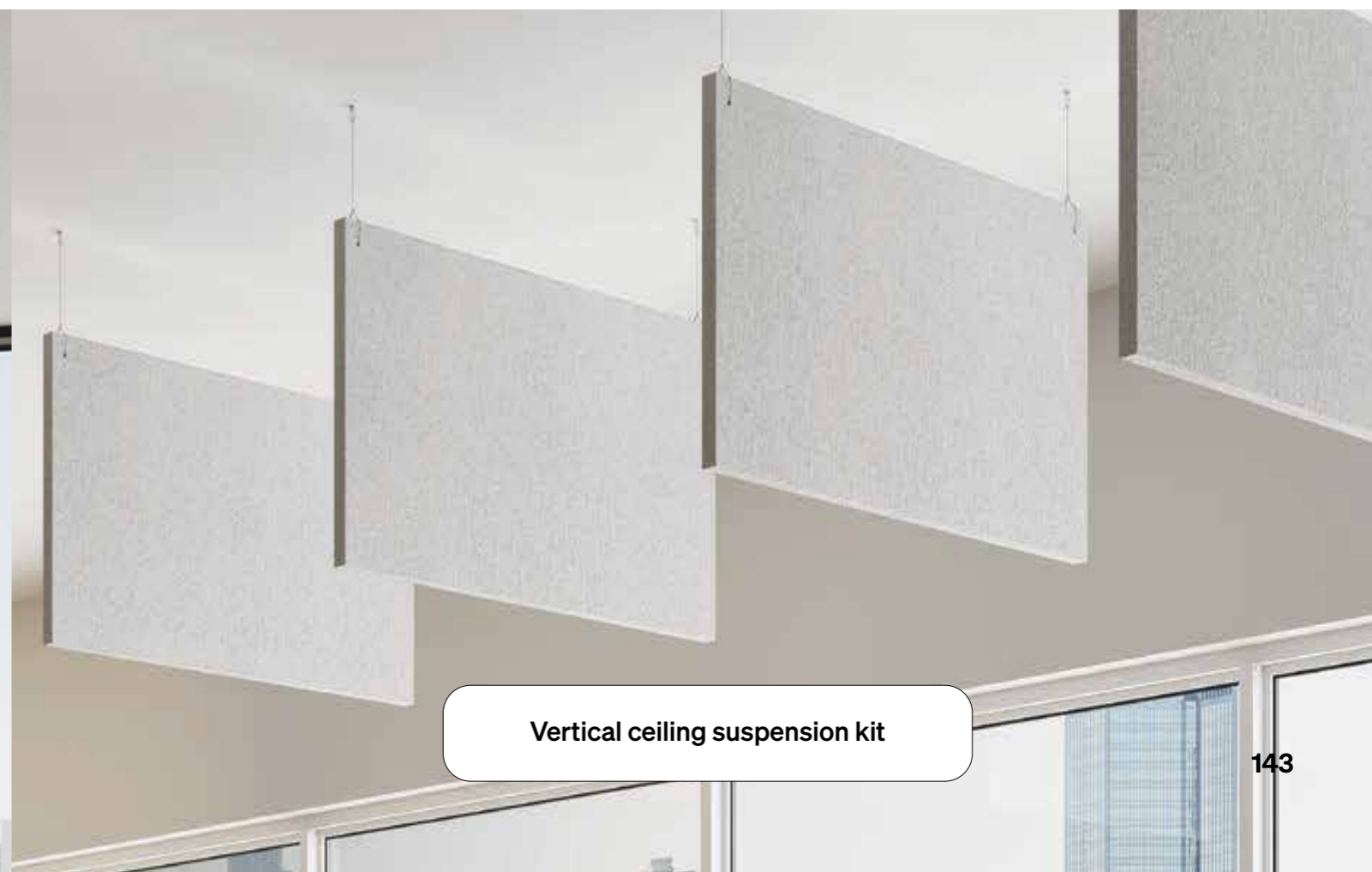

Vertical ceiling suspension kit

## Perfect acoustics, total flexibility

Our sound-absorbing panels on wheels are designed to meet the needs of modern schools. Available in different sizes and heights, they offer a versatile solution to dynamically organize spaces, creating quieter and more functional environments. Thanks to their mobile structure, they can be easily moved to adapt to laboratories, temporary classrooms, group activities or moments of individual concentration. The sound-absorbing material significantly reduces reverberation and noise, improving the quality of teaching and learning. Practicality, design and acoustic well-being: all in one panel.



## Sound absorbing panel 80×160

Cod. PANAC80160 £374.00 + VAT

Sound-absorbing panel covered in fireproof faux leather, size 80 x h. 160 cm

Colors  C28  C62  C26  C61



## Sound absorbing panel 100×160

Cod. PANAC100160 £374.00 + VAT

Sound-absorbing panel covered in fireproof faux leather, size 100 x h. 160 cm

Colors  C28  C62  C26  C61

## Sound absorbing panel 120×160

Cod. PANAC120160 £505.00 + VAT

Sound-absorbing panel covered in fireproof faux leather, size 120 x h. 160 cm

Colors  C28  C62  C26  C61



## Sound absorbing panel 80×180

Cod. PANAC80180 £407.00 + VAT

Sound-absorbing panel covered in fireproof faux leather, size 80 x h. 180 cm

Colors  C28  C62  C26  C61

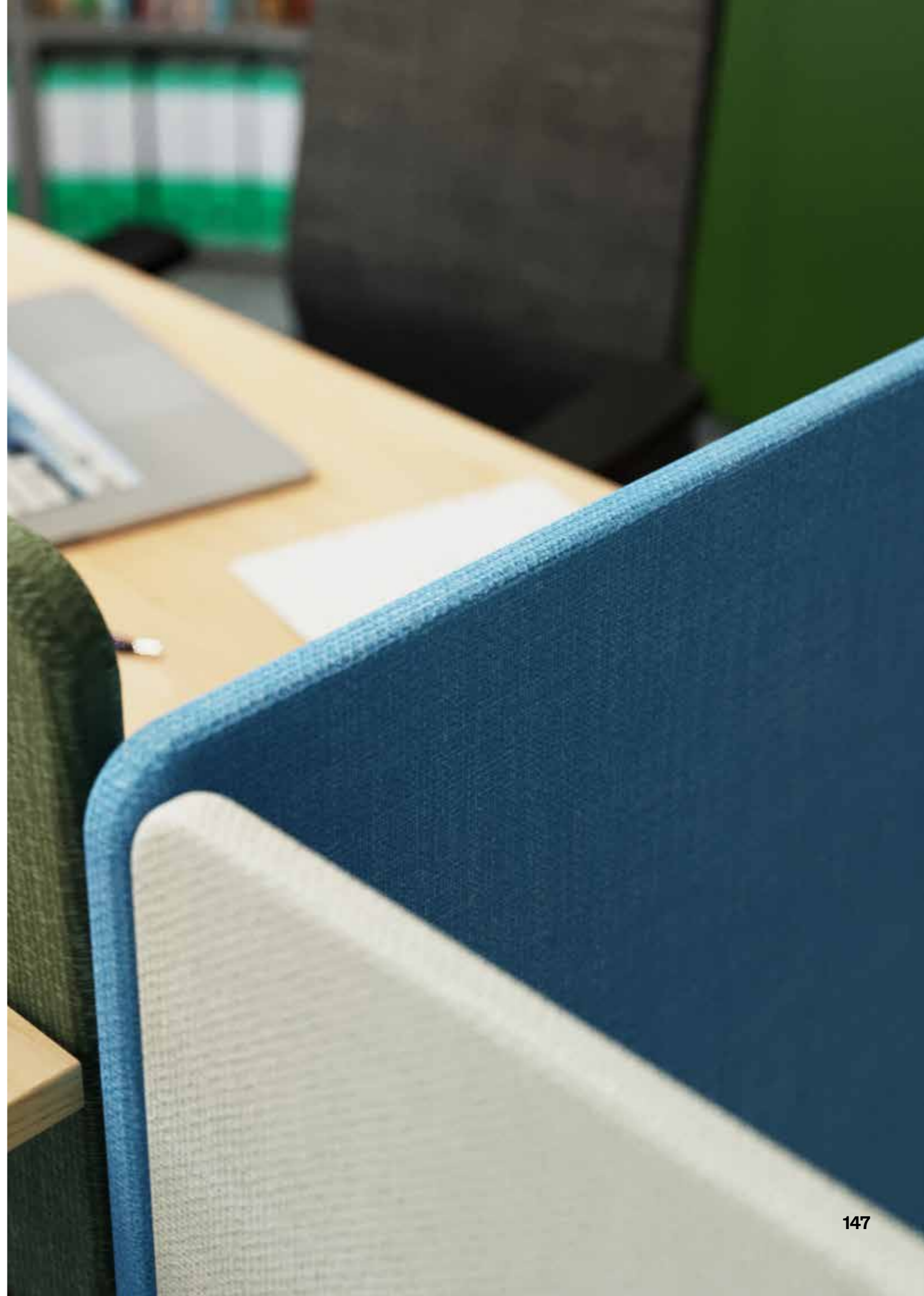

# Manage the space, control the sound



## Sound absorbing panel 100×180

Cod. PANAC100180 £473.00 + VAT

Sound-absorbing panel covered in fireproof faux leather, size 100 x h. 180 cm

Colors ● C28 ● C62 ● C26 ● C61



## Sound absorbing panel 120×180

Cod. PANAC120180 £523.00 + VAT

Sound-absorbing panel covered in fireproof faux leather, size 120 x h. 180 cm

Colors ● C28 ● C62 ● C26 ● C61



STRPIEDEG

Fixed feet kit in grey metal  
N.B. Always order 2 pieces for each panel

£23.00 + VAT



STRRUOTABG

Grey metal feet on wheels kit  
N.B. Always order 2 pieces for each panel

£40.00 + VAT



PNCONDR

Gray metal linear joint

£12.00 + VAT



PNCONANG

Gray metal corner joint

£17.00 + VAT



PNCNT

3-way grey metal joint

£23.00 + VAT

Add color code to item code when ordering.



SMARTARREDA

# Complements and accessories

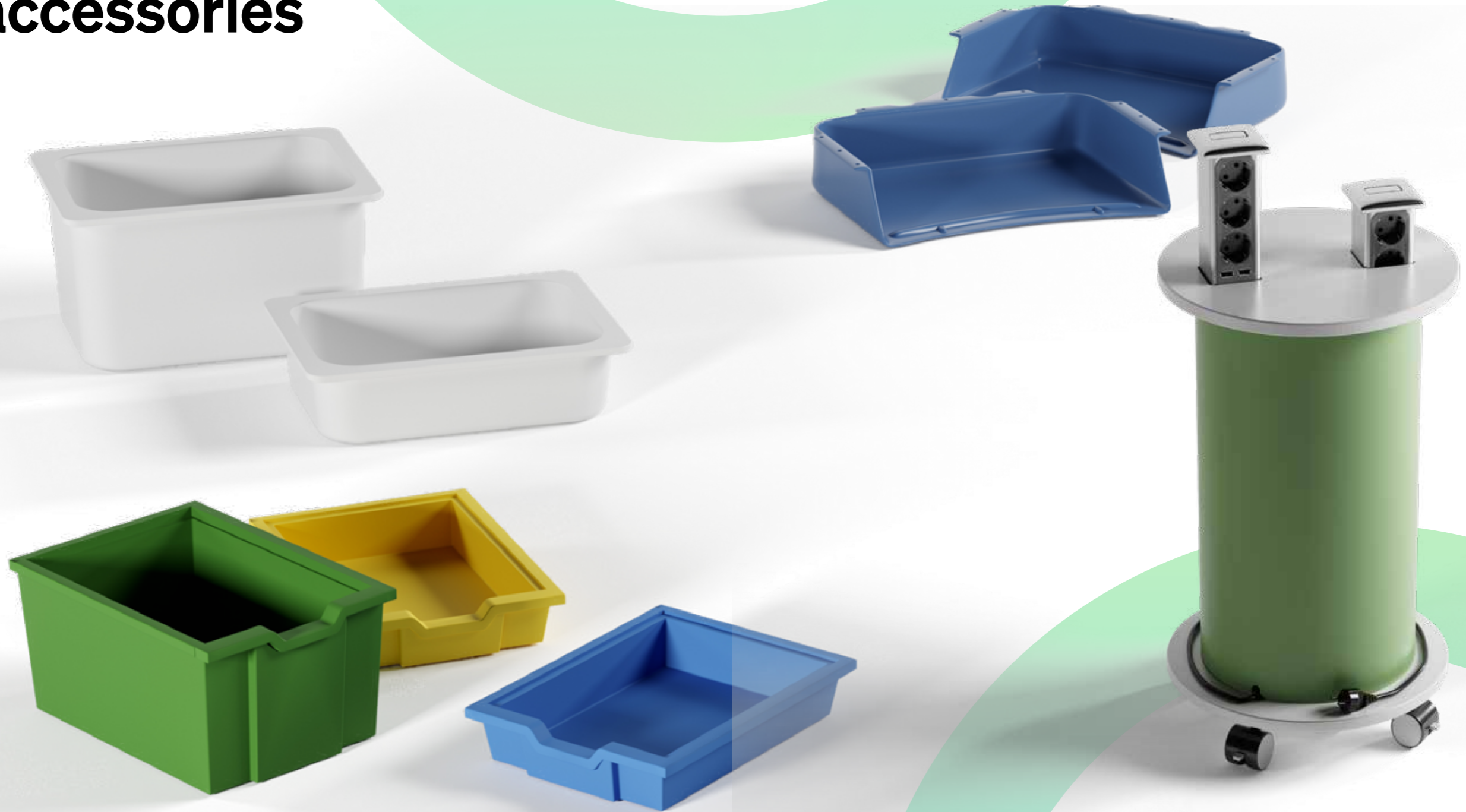



**Cod. TS01**      **Small colored tray**      **£13.00 + VAT**

Small polypropylene tray  
dim. 31.2 x 43 x h 7.5 cm,  
applicable only to the L45 module

Colors   ● B   ● G   ● R   ● Y



**Cod. TL01**      **Large colored tray**      **£26.00 + VAT**

Large polypropylene tray  
dim. 31.2 x 43 x h 22.5 cm,  
applicable only to the L45 module

Colors   ● B   ● G   ● R   ● Y



**Cod. TSDB01**      **Small polypropylene tray**      **£23.00 + VAT**

Small polypropylene tray  
complete with metal guides  
30 x 42 x h 10 cm

Colors   ● B   ● G   ● R   ● Y



**Cod. TLDB01**      **Big polypropylene tray**      **£42.00 + VAT**

Large polypropylene tray  
complete with metal guides  
30 x 42 x h 23

Colors   ● B   ● G   ● R   ● Y



**Cod. TRVS01**      **Undertop for tables**      **£19.00 + VAT**

Undercounter/plastic box  
for desks 51 x 35 x h 10 cm

Colors   ● B   ● G   ● R   ● Y   ● GR





Cod. CBWHCH04

**Wheel with brake**

£33.00 + VAT

Wheel with brake for furniture and lockers  
( p.u.d. ) 75 kg. each pack of 4 pieces



Cod. 110586735

**Pair of tray guides**

£23.00 + VAT

Pair of tray guides,  
**compatible with TS01 and TL01 applicable  
only on open locker units, do not use doors**



Cod. LFWHCH01

**Rubberized wheel**

£6.00 + VAT

Rubber wheel for  
lift vega chairs



**Adhesive numbers for lockers**

£21.00 + VAT

Cod. LKNAT1UT10

from 1 to 10

Cod. LKNAT1UT20

from 11 to 20

Cod. LKNAT1UT30

from 21 to 30

Cod. LKNAT1UT40

from 31 to 40

Cod. LKNAT1UT50

from 41 to 50



Cod. TBWHCH04

**Wheel with brake**

£21.00 + VAT

Wheel with brake for tables  
75 kg each (pack of 4)



Cod. EN-CTPG

**Colorful pen holder**

£13.00 + VAT

Polypropylene side pen holders  
**Compatible with EN-CT table only**

Colors ● BL ● GR ● RE ● YE ● NI



Cod. EN-CRUN

**Pair of tray guides  
under-desk containers**

£29.00 + VAT

**Only compatible with EN - CORE  
tables paired with 'TS' trays**



Cod. EN-CTCON

**Table connection**

£43.00 + VAT

Connection for polypropylene table  
**Only compatible with EN-CT table**

Colors ● BL ● NI



Cod. ACPZ-ST

**Backpack hook**

£8.00 + VAT

Metal backpack hook for table



Cod. OZ-Y

**Colorful wall coat rack**

**£10.00 + VAT**

PVC coat hanger 2+1. Add pieces 2 knobs

Colors  WH  BL



Cod. OZ-I

**Colorful wall coat rack**

**£7.00 + VAT**

PVC coat hanger 1+1. Add pieces 1 knob

Colors  WH  BL



Cod. POMOLO

**PVC knob for coat hanger**

**£3.00 + VAT**

PVC knob for coat hanger code OZ-Y and OZ-I

Colors  BL  GR  RE  YE



Cod. 551-22W

**School trolley**

**£483.00 + VAT**

for books or educational games  
with wheels and brake  
Dim. 84x55.8 x h 77.5 cm

Structure color  WH

Side colors  WH



Cod. SMARTHUB

**Charging column**

**£1,462.00 + VAT**

Circular charging column  
on wheels with 2 retractable turrets  
(6 unel + 4 USB)  
Dim. Ø45h 76 cm (fixed)

Top and base  WH

Structure  RAL9003  RAL7035  RAL1023

RAL3002  RAL5014  RAL6021

Add color code to item code when ordering.



## Prices

End user TAX excluded

## Transport

prices shown are not included shipping costs - see the "transport" section in the next page for reference.

## Delivery

Tables and chairs immediately available (if not sold out).  
All other items are available within 30 working days from the order confirmation.

## Warranty

As per law, please refer to the general warranty conditions published on our website [smartarreda.com](https://www.smartarreda.com)

**The colors used in this document are indicative and not binding.** For the choice of color, we recommend contacting your SmartArreda representative and **viewing the color and component swatch in person.**

## General Terms and Conditions of Sale

---

- **The present price-list cancels and replace the previous ones.**
- **Smart Arreda S.r.l reserves the right to make technical, dimensional and aesthetic changes in production.**
- **Packing: it is free or charge in standard carboard boxes. Any particular packing requested in advance, will be invoiced at its cost.**
- **Transport: The goods will be made available at our logistics facilities (Incoterms® 2020 - EXW, Ex Works.**  
**All costs, charges, risks, and responsibilities related to the transportation of the goods from the indicated place of delivery shall be borne by the buyer. The seller undertakes to make the goods available to the buyer, properly packed for shipment, by the agreed date. Any export customs operations, if required, shall be carried out and paid for by the buyer, unless otherwise agreed in writing.**
- **Complaints: any defects in production must be notified in writing within 8 days from the receipt of the goods.**
- **Prices do not include VAT and are valid until the present price list has been replaced.**
- **The present conditions are declare accepted with placing the order**



**SMARTARREDA**

smartarreda.com



# SMARTARREDA

Via Giovanni Spadolini, 7 | 20141 Milan (MI) | ITALY

Tel. (+39) 02.89617595 | [info@smartarreda.com](mailto:info@smartarreda.com) | [smartarreda.com](http://smartarreda.com)

