



**Mobili Alti\_**  
Istruzioni di montaggio

**High cabinets\_**  
Assembly instructions



## IT

I nostri prodotti sono progettati e fabbricati secondo i regolamenti delle normative sulle dimensioni e requisiti di sicurezza

### Introduzione

Prima dell'uso leggere con attenzione il presente manuale e attenersi scrupolosamente a quanto indicato. Conservare per futuri riferimenti. Il fabbricante declina ogni responsabilità per conseguenze derivanti da un uso non conforme. Il legno utilizzato è ricavato da fonti sostenibili, nel pieno rispetto delle normative in ambito di disboscamento illegale.

### Presentazione prodotto

Questi armadi pratici e dal design raffinato rappresentano una soluzione utilissima per contenere documenti, effetti personali, strumenti didattici etc. Si adattano ad ogni spazio, rendendolo confortevole ed elegante. Possono essere collocati a ridosso di una parete o all'interno di open space per creare gli spazi desiderati e vivere al meglio l'ufficio, la casa o la scuola.

### Norme d'uso generale

Non esporre il prodotto alle intemperie, all'umidità e agli agenti atmosferici in genere. Gli armadi sono strumenti ad uso didattico o di lavoro e devono essere utilizzati per l'uso previsto. Non usare in modo improprio. È assolutamente vietato salire in piedi, utilizzare come scaleo, aggrapparsi o fare quanto possa rivelarsi estremamente dannoso e inficiare sulla sicurezza, sulla stabilità ed integrità del medesimo. Assicurarsi che il prodotto sia stabile e posizionato su piani stabili orizzontali. Evitare il sovraccarico. Non utilizzare a ridosso di fonti di calore, quali stufe e termosifoni che potrebbero col tempo procurare danni e deformazioni alle strutture. In caso di spostamenti, non trascinare lungo il pavimento, ma svuotare, sollevare e appoggiare nella posizione desiderata.

### Pulizia

Durante le operazioni di pulizia, non utilizzare detergenti contenenti alcol, solventi o tensioattivi. Non usare agenti chimici. Non usare oggetti abrasivi. Pulire con un panno morbido e umido privo di pelucchi, quindi passare un panno asciutto per asciugare. Non spruzzare detergenti o acqua direttamente sull'armadio, ma spruzzare sempre direttamente sul panno utilizzato per la pulizia. Non usare getti d'acqua o detergenti liquidi per la pulizia dei pavimenti o di altre superfici, vicino alla struttura del locker, per evitare schizzi accidentali che potrebbero deteriorare la finitura superficiale dello stesso.

### Installazione

Collocare su una superficie piana, stabile e resistente, non soggetta a vibrazioni di alcun tipo. I carichi devono essere uniformemente distribuiti, non devono superare 8 Kg per ogni ripiano e 5 kg per ogni cassetto. Per maggiore sicurezza riporre gli oggetti più pesanti nel cassetto inferiore. Non collocare la TV o altri oggetti pesanti sull'armadio.

### Manutenzione

Periodicamente verificare lo stato di usura dell'armadio, degli eventuali accessori, ed effettuare, ad intervalli regolari, gli opportuni controlli di stabilità.

### Smaltimento e riciclaggio

Le parti in legno sono riciclabili. Prima di dismettere il prodotto, eliminare le parti in metallo e plastica. Non disperdere il prodotto e il relativo imballo nell'ambiente. Conferire alla fine del ciclo di vita nelle apposite strutture previste dalle norme vigenti.

## EN

Our products are designed and manufactured according to the regulations on dimensions and safety requirements.

### Introduction

Before use, carefully read this manual and carefully follow the instructions. Keep for future reference. The manufacturer declines all responsibility for later consequences of improper use. The wood used is obtained from sustainable sources, in full compliance with the regulations on illegal deforestation.

### Presentazione prodotto

These practical and finely designed cabinets represent a very useful solution to contain documents, belongings, teaching tools etc. They suit any space, making it comfortable and elegant. They can be placed close to a wall or inside an open space to create the desired environment and live at best your office, home or school.

### General use rules

Do not expose the product to bad weather, humidity and atmospheric agents in general. Cabinets are tools for teaching or work use and must be used for their intended use. Do not use improperly. It is absolutely forbidden to climb up, use as a ladder, cling to or do anything that can be extremely harmful and affect the safety, stability and integrity of the unit. Make sure the locker is stable and placed on stable horizontal surfaces. Avoid overload. Do not use close to heat sources, such as stoves and radiators, which could cause damage and deformation to the structures over time. When moving, do not drag along the floor, but empty, lift and place in the desired position.

### Cleaning

When cleaning, do not use detergents containing alcohol, solvents or surfactants. Do not use chemicals. Do not use abrasive objects. Clean with a soft, damp, lint-free cloth, then wipe with a dry cloth. Do not spray detergents or water directly on the cabinet, but always spray directly on the cloth used for cleaning. In order to avoid accidental splashes that could deteriorate the surface finish, do not use jets of water or liquid detergents for floors or other surfaces near the locker structure.

### Installation

Place on a flat, stable and resistant surface, not subject to vibrations of any kind. The loads must be evenly distributed, they must not exceed 8 kg for each shelf and 5 kg for each drawer. For added safety, please store heavier items in the lower drawer. Do not place TV or other heavy objects on the cabinet.

### Maintenance





Periodically check the state of wear of the cabinet and of any accessories. Carry out, at regular intervals, the appropriate stability checks.

### Disposal and recycling

The wooden parts are recyclable. Before disposal discard the metal and plastic parts. Do not dispose the product and its packaging in the environment. Confer at the end of the life cycle in the appropriate structures provided for by the regulations in force.

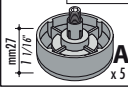
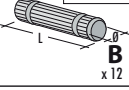
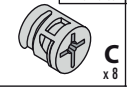
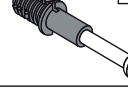
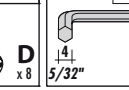
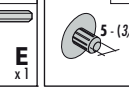

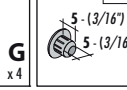
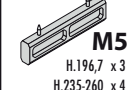
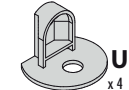
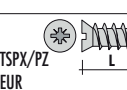

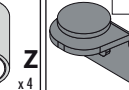
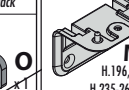
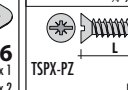
<b>CODE</b> 504315005	<b>COLOUR</b> NERO black	<b>CODE</b> 505060902	<b>Ø x L</b> 8 x 30	<b>CODE</b> 505032201	<b>COLOUR</b> ZINCATO Zinc Plated	<b>CODE</b> 505032301	<b>Ø</b> 8 - 5/16"	<b>COLOUR</b> ZINCATO Zinc Plated	<b>CODE</b> 505182201	<b>COLOUR</b> FERRO iron	<b>CODE</b> 505131031	<b>COLOUR</b> BIANCO white	<b>CODE</b> 505022951	<b>COLOUR</b> NYLON	<b>CODE</b> 505130131	<b>COLOUR</b> BIANCO white
	A x 5		B x 12		C x 8		D x 8		E x 1		F x 4		G x 4		H x 2	
<b>CODE</b> 423413009	<b>COLOUR</b>	<b>CODE</b> 505171109	<b>COLOUR</b> NYLON	<b>CODE</b> 506924919	<b>Ø x L</b> 6 x 9	<b>COLOUR</b> ZINCATO zinc plated	<b>CODE</b> 505171009	<b>COLOUR</b> NYLON	<b>CODE</b> 505173009	<b>COLOUR</b> NERO black	<b>CODE</b> 423413019	<b>COLOUR</b> NICKEL	<b>CODE</b> 506940309	<b>Ø x L</b> 3,5 x 15	<b>COLOUR</b> ZINCATO 1/4" x 1/2" zinc plated	
	M5 H.196,7 x 3 H.235-260 x 4		U x 4		V x 4		Z x 4		O x 4		M6 H.196,7 x 1 H.235-260 x 2		M7 H.196,7 x 3 H.235-260 x 6			

Per il montaggio della struttura operare con il mobile poggiato a terra su un fianco seguendo la numerazione  
While assembling, place the cabinet on a side on the floor and follow the numbers

**Fasi 1 - 2 - 3 - 4 - 5 - 6 - 7 - 8 - 9 - 10 - 11**  
Phases 1 - 2 - 3 - 4 - 5 - 6 - 7 - 8 - 9 - 10 - 11

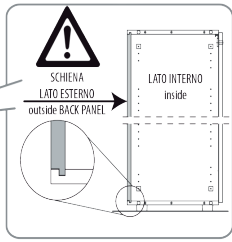
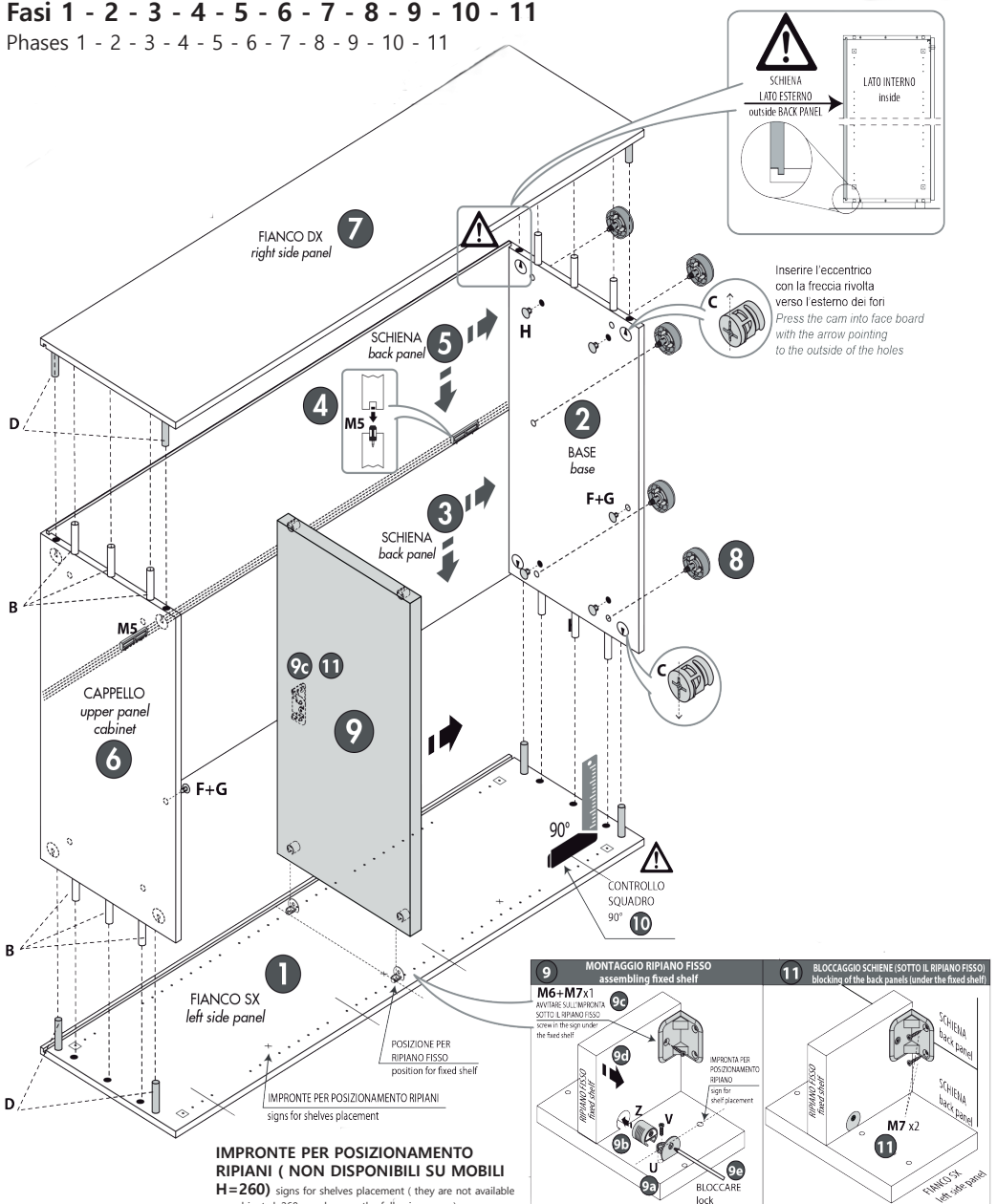

NEL CASO DI MOBILI DIREZIONALI CON BASE AGGIUNTIVA I PIEDINI VANNO INSERITI SU QUEST'ULTIMA in case of executive furniture with an additional base the legs are screwed under the latter

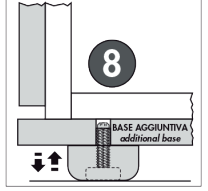

Inserire l'eccentrico con la freccia rivolta verso l'esterno dei fori  
Press the cam into face board with the arrow pointing to the outside of the holes

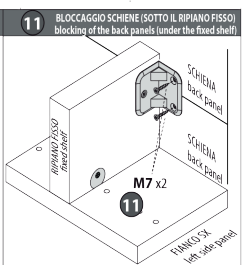
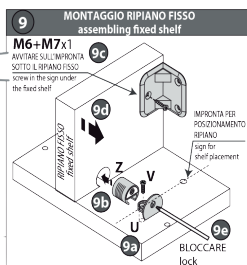

IMPRONTE PER POSIZIONAMENTO RIPIANI (NON DISPONIBILI SU MOBILI H=260) signs for shelves placement (they are not available on cabinets h.260 see draw on the following page)

➤ **Segue**  
assembling in the following page





Fase 12 - 13 | Phases 12 - 13

CODE	COLOUR	CODE	COLOUR	CODE	COLOUR
505171309	NYLON	505171209	NYLON	505173009	NERO <i>black</i>

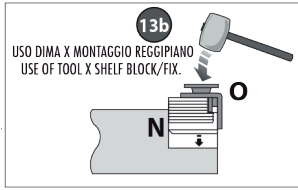

102/F	CODE	COLOUR
 8 - (5/16") L 10 - (3/8") L x 5	505130317	GRIGIO 20 <i>grey 20</i>
	505130331	BIANCO <i>white</i>
	505130333	BEIGE 15 <i>beige 15</i>
	505130345	WENGE <i>WENGE</i>
	505130356	ANTRACITE <i>anthracite</i>

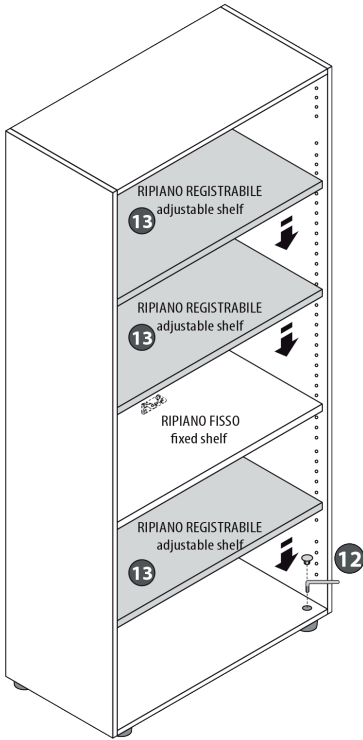

12 Regolazione piedino adjustable foot

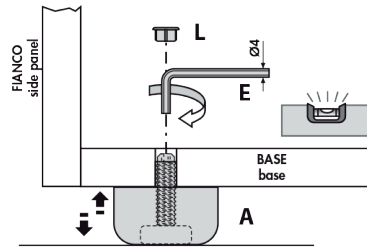

13 Montaggio ripiano registrabile Assembling adjustable shelf

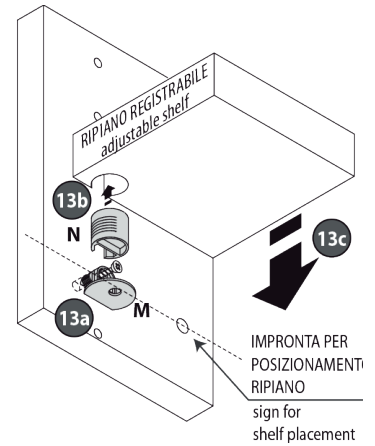

Fase 14 - 15 | Phases 14 - 15

CODE	Ø x L	COLOUR	CODE	Ø x L	COLOUR
505094002	5 x 30	FERRO	506911509	4MA x 15	ZINCATA
3/16" x 1 3/16" - iron					
4MA x 11/16" - zinc plated					

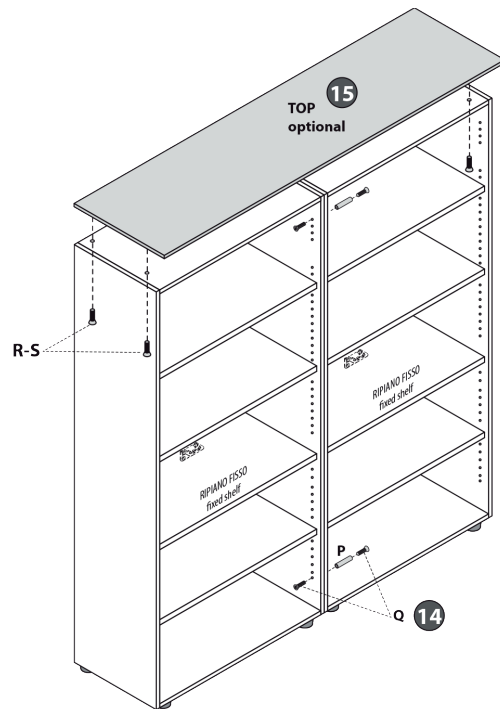
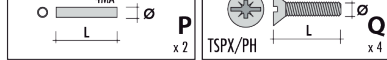

Viti per base e Top sp. 12 mm  
screws for base and top  
thick. 12 mm

CODE	Ø x L	COLOUR
506912509	4MA x 25	ZINCATA
4MA x 1" - zinc plated		

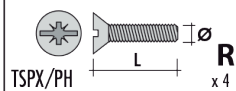

Viti per base e Top sp. 18-25 mm  
screws for base and top thick. 18-25 mm

CODE	Ø x L	COLOUR
506941909	3,5 x 30	ZINCATA
1/8" x 1 3/16" - zinc plated		

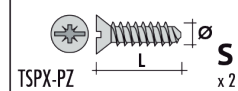



**Ante Legno\_**  
Istruzioni di montaggio

**Wooden doors\_**  
Assembly instructions

CODE	COLOUR	CODE	COLOUR	CODE	COLOUR	CODE	Ø x L	COLOUR	CODE	COLOUR	CODE	Ø x L	COLOUR	CODE	COLOUR	CODE	Ø x L	COLOUR
S07051019	NICKEL	S07062319	NICKEL	404400409	ARGENTO	S06940309	3,5 x 15	ZINCATA	S07080800	ZINCATA	S06540408	3 x 15	BRUNITA	S08019019	ARGENTO	S06110108	4MA x 22,5	ZINCATA
nickel		nickel		silver		1/8" x 9/16" - Zinc Plated		zinc plated		1/8" x 9/16" - burnished		silver		4MA x 7/8" - zinc plated				
CODE	COLOUR	CODE	COLOUR	CODE	COLOUR	CODE	COLOUR											
S05130107	NERO	S05130117	GRIGIO 20	S05130131	BIANCO	S05130133	BEIGE 15											
102/B		102/B		102/B		102/B												
black		grey 20		white		beige 15												

PER IL MONTAGGIO SEGUIRE LE FASI NUMERATE  
Assembling following the numbered phases

Fase 1 - 2 - 3 - 4 - 5 - 6 - 7 | Phases 1 - 2 - 3 - 4 - 5 - 6 - 7

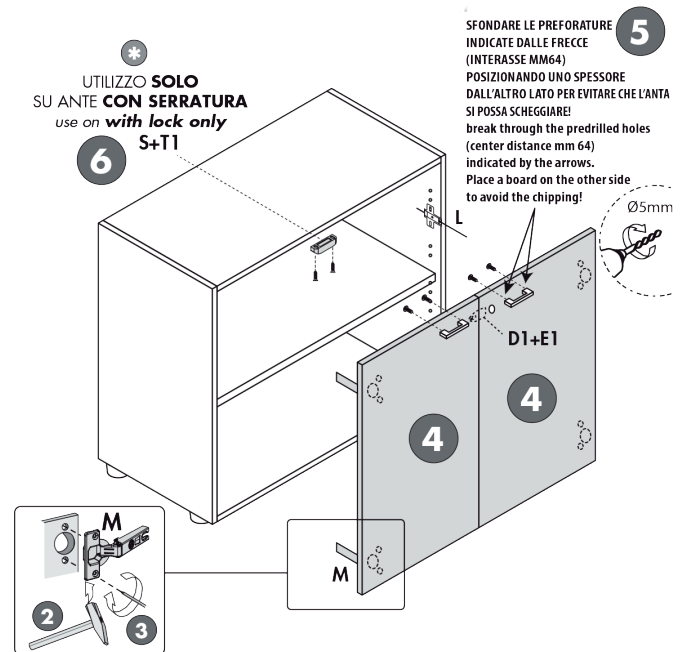
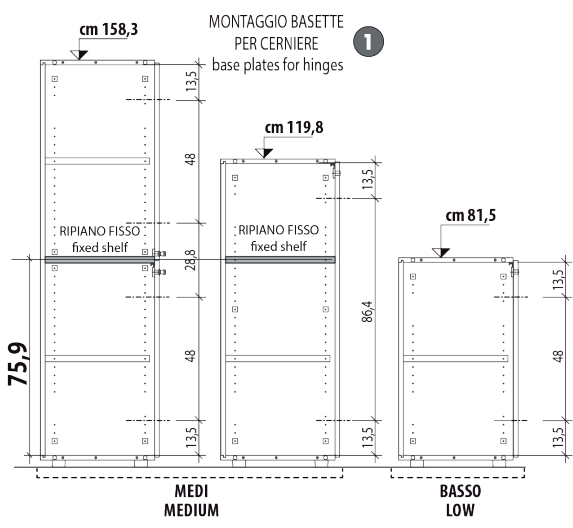

Montaggio ante  
Assembling doors **4**

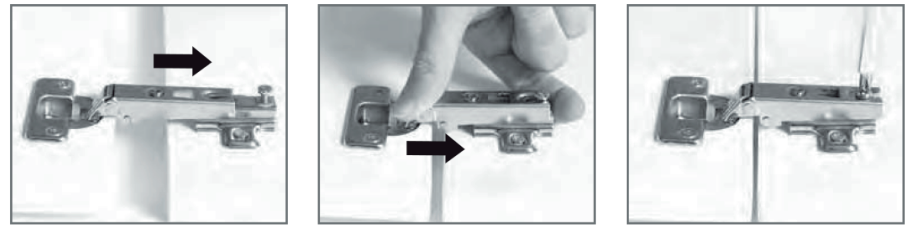

- 4a** Posizionare la parte anteriore della cerniera nella parte anteriore della basetta. Place the rear part of the hinge on the front side of the mounting plate.
- 4b** Far scivolare la cerniera sulla basetta fino all'arresto. Let the hinge slide on the mounting plate until it stops.
- 4c** Fissare la vite di connessione. Tighten the connecting screw.

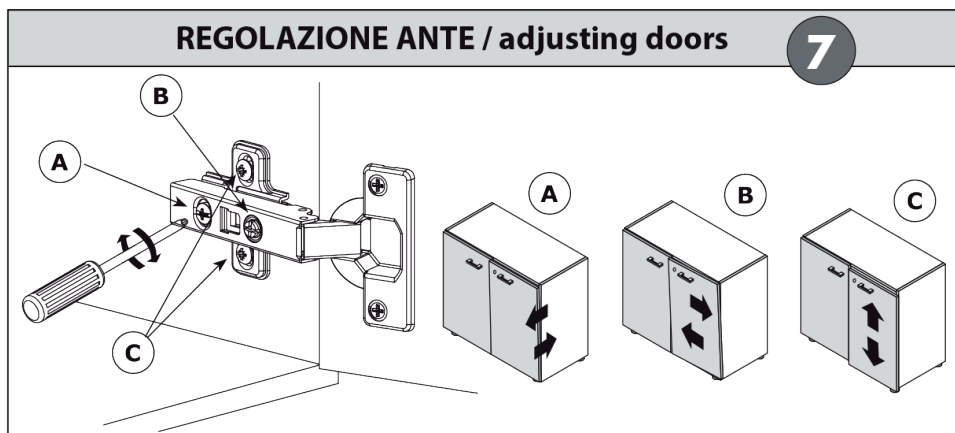
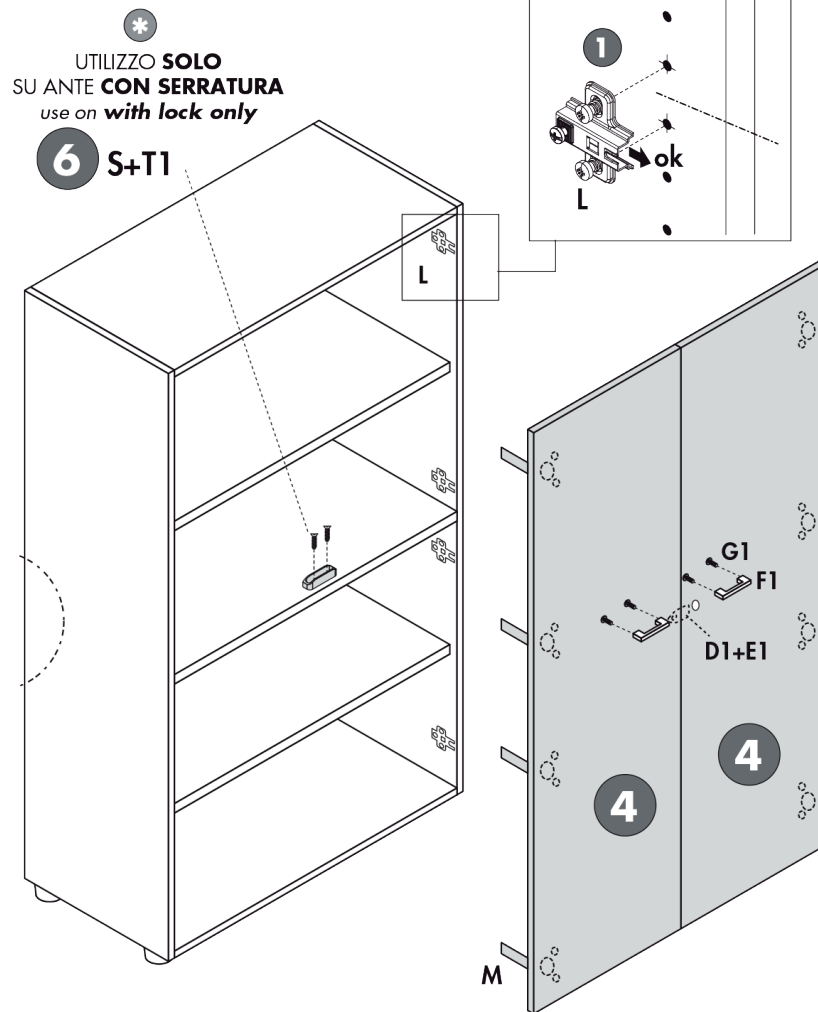



MONTAGGIO BASETTE  
PER CERNIERE  
base plates for hinges

ANTE INTERE  
whole doors

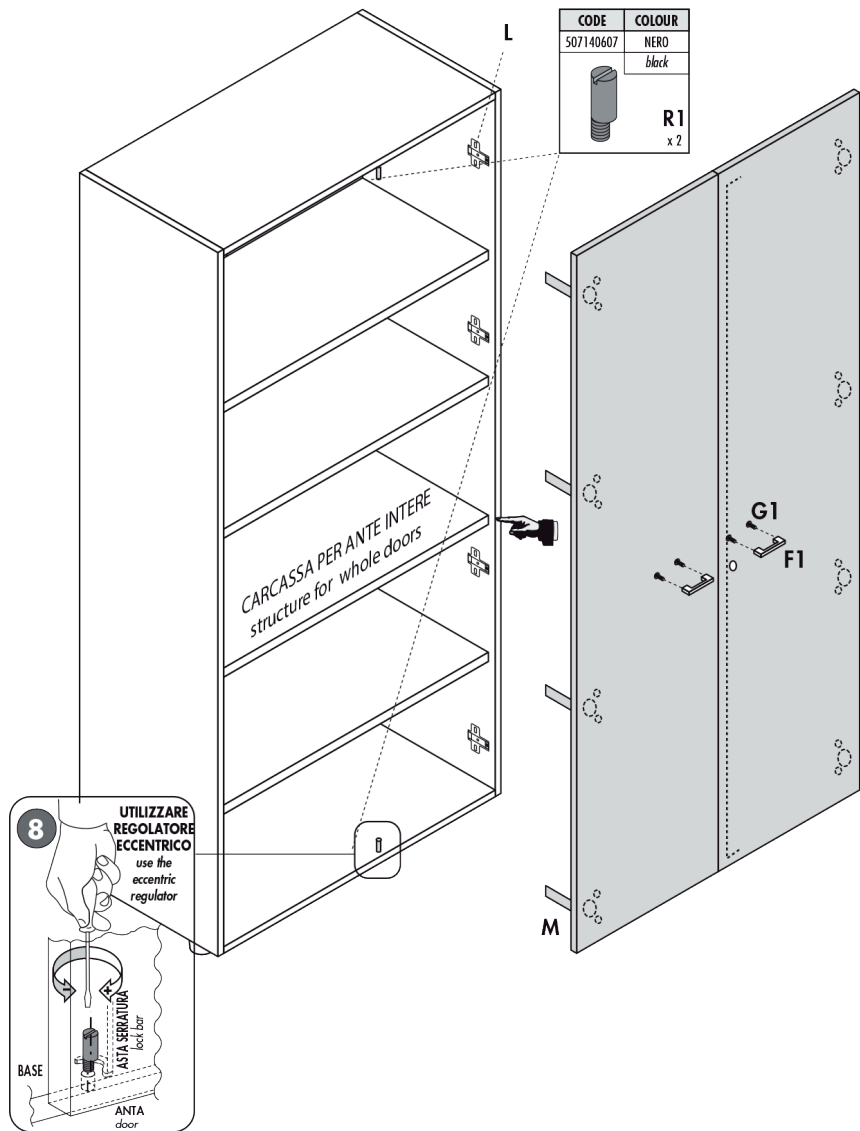
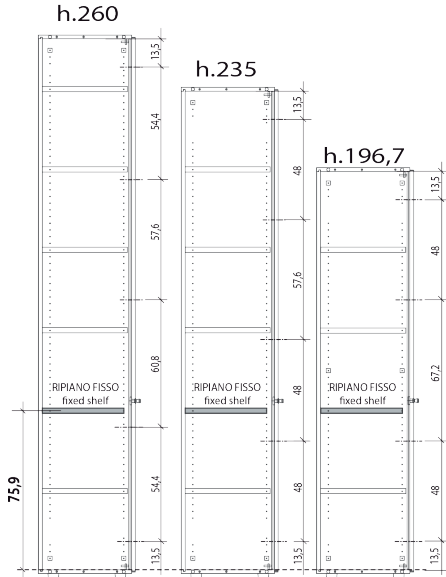

CROSSING BORDERS

Motris srl  
Viale Virgilio,20  
74121 Taranto  
info@motris.it  
www.motris.it